



|studio|
MINUTES*matter*|

Copyright © 2009 by Minutes Matter Solutions, Inc. All rights reserved.
Printed in the United States of America. Except as permitted under the
Copyright Act of 1976, no part of the publication may be reproduced or
distributed in any form without written consent of the publisher.



STYLE GUIDE

| About Us |

Creating your personal or business space is a fun and easy process. Using our experience we guide you through the various products, styles and services to ensure that both the design concept and functionality are achieved. Our ideas are tailored to reflect your style in fabric, color choices, treatments, and bedding options. This style guide is a sample of the many unique treatments we can create for you. Once we have a better understanding of your taste, we can computer-illustrate a detailed sketch of the design ideas being discussed. This process helps you visualize the treatment before fabrication begins. From the initial meeting to the finished product, you will be delighted with each stage of the design process.

We look forward to providing you with an experience that is simply unforgettable!

Enjoy!



Style:

Cornices and
— Lambrequins



Cornices and Lambrequins

| Arched and Raised |

1

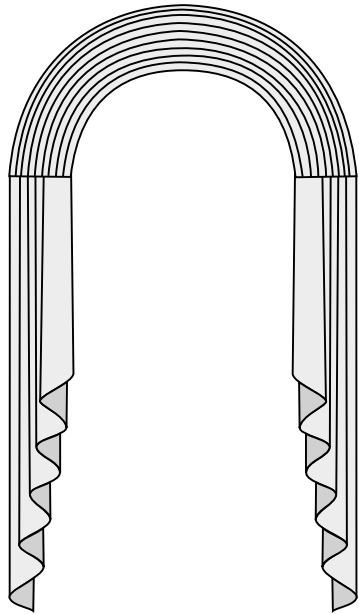

~ Corded Arch w/Cascades ~

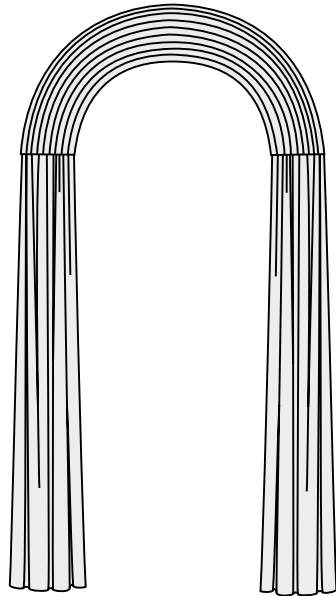

~ Corded Arch w/Drapery ~

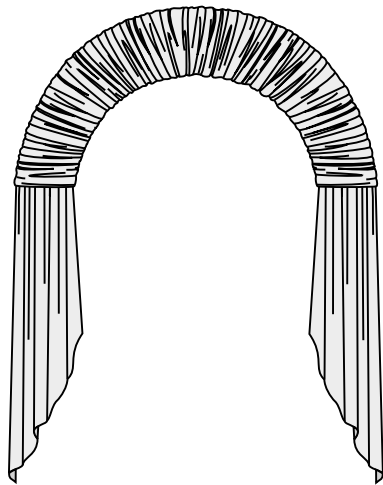

~ Shirred Arch w/Cascades ~

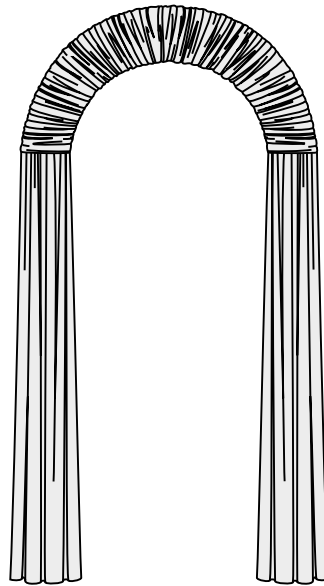

~ Shirred Arch w/Draperies ~

Cornices and Lambrequins

|Soft and Hard|

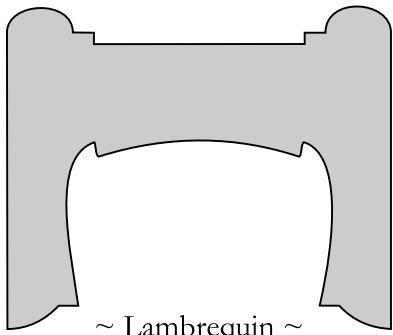

~ Lambrequin ~

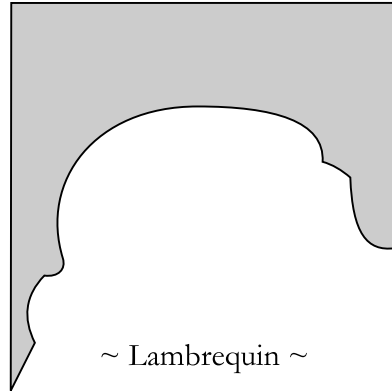

~ Lambrequin ~

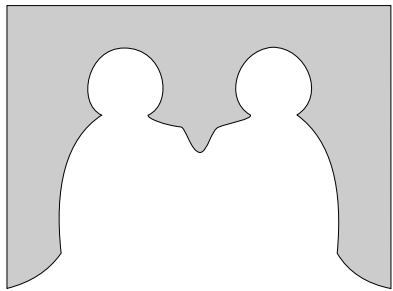

~ Lambrequin ~

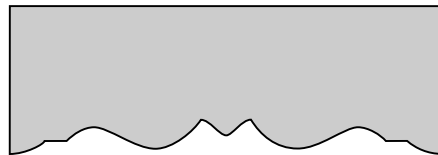

~ Center Point w/Double Scallops ~

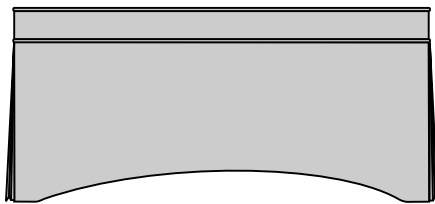

~ Cornice w/Skirted Arch Valance ~



~ Ondule Cornice ~

Cornices and Lambrequins

|Soft and Hard|

1



~ Plain Cornice ~

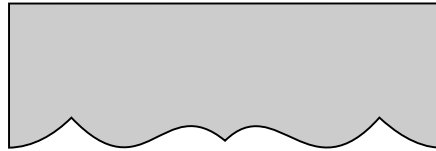

~ Points and Scallops Cornice ~

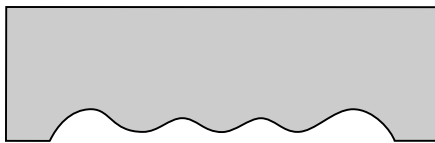

~ Scalloped Cornice ~

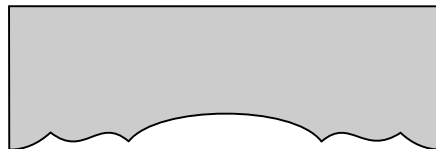

~ Scalloped Cornice ~

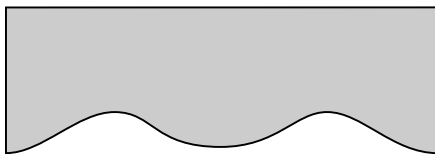

~ Scalloped Cornice ~

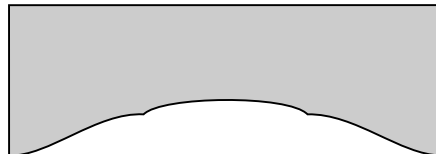

~ Scalloped Cornice ~

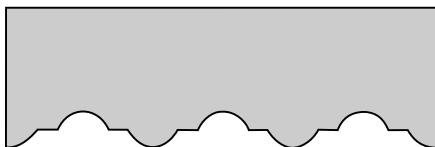

~ Scalloped Cornice ~



~ Scalloped w/Straight Center ~

Cornices and Lambrequins

|Soft and Hard|

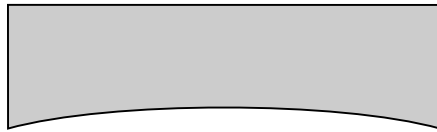

~ Soft Cornice ~



~ Soft Cornice ~

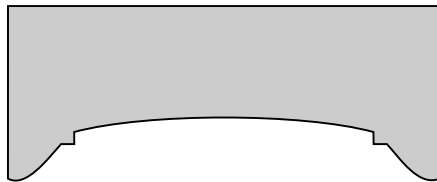

~ Soft Cornice ~

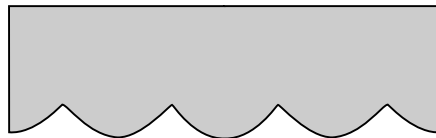

~ Soft Cornice ~

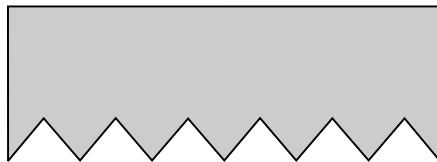

~ Soft Cornice ~

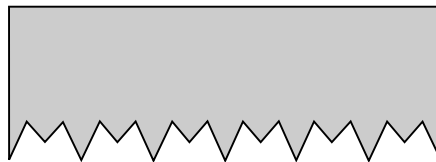

~ Soft Cornice ~

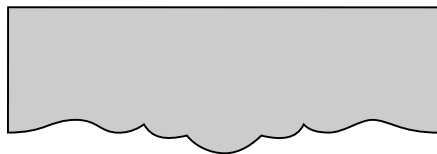

~ Soft Cornice ~

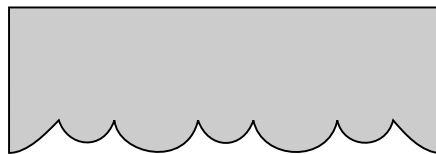

~ Soft Cornice ~

Cornices and Lambrequins

| Soft and Hard |

1

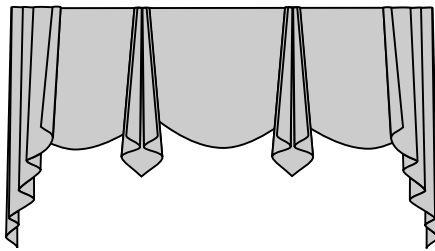

~ Soft Cornice ~

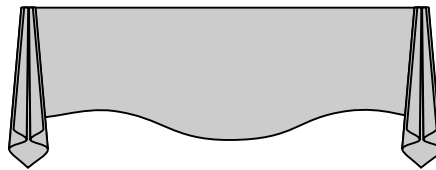

~ Soft Cornice ~

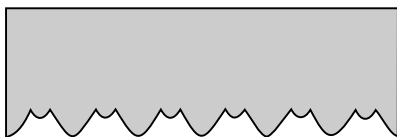

~ Soft Cornice ~

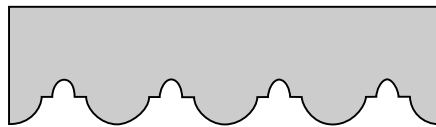

~ Soft Cornice ~

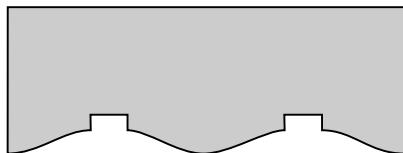

~ Soft Cornice ~

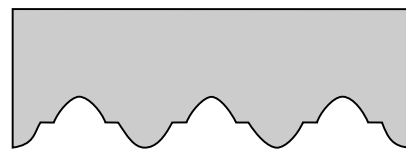

~ Soft Cornice ~



~ Soft Cornice ~

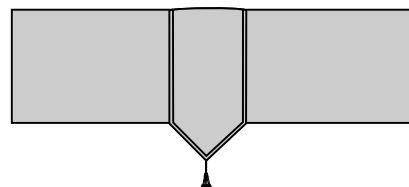

~ Straight Cornice w/Banner ~

Cornices and Lambrequins

| Soft and Hard |

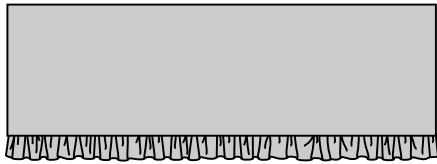

~ Straight Cornice w/Ruffle ~

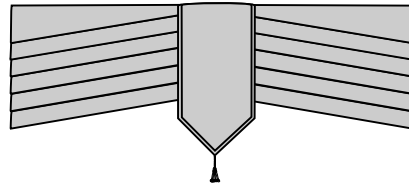

~ Tapered Pleated Soft Cornice ~

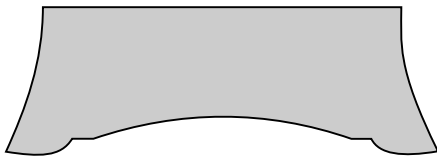

~ Upholstered Cornice ~

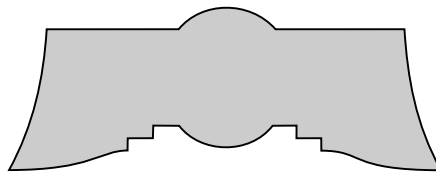

~ Upholstered Cornice ~

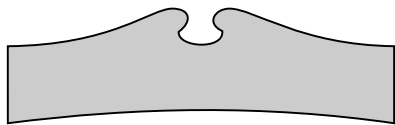

~ Upholstered Cornice ~



~ Upholstered Cornice ~

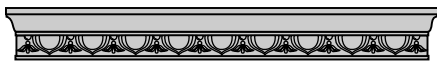

~ Wood Cornice ~



~ Wood Cornice ~

Style:

Drapery
— Designs



Draperies Designs

| Arched and Raised |

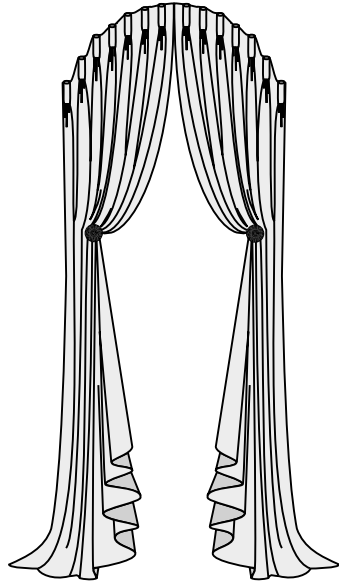

~ Cartridge Pleat ~

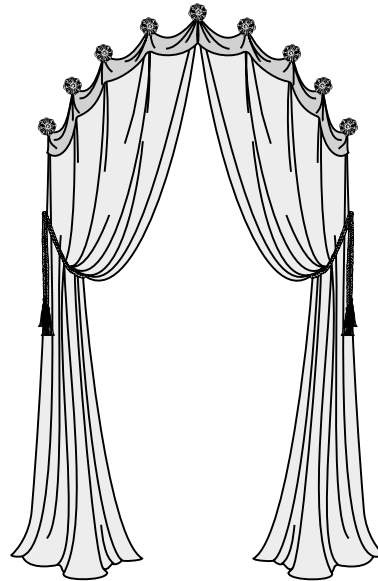

~ Cuffed Drapery ~

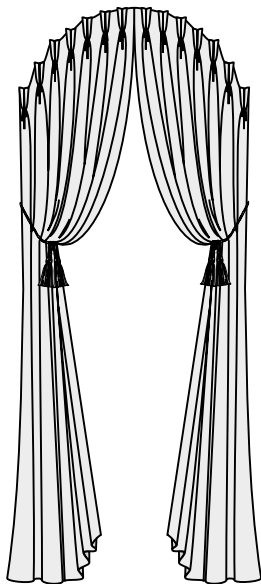

~ Fan Pleat ~

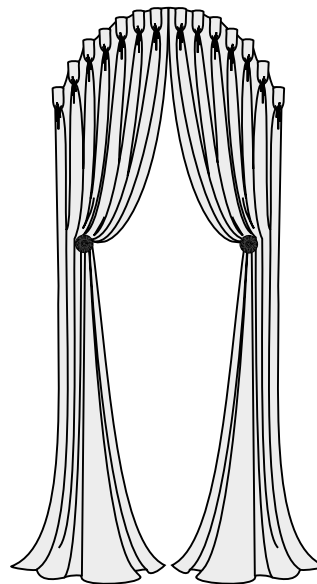

~ Goblet Pleat ~

Drapery Designs

| Arched and Raised |

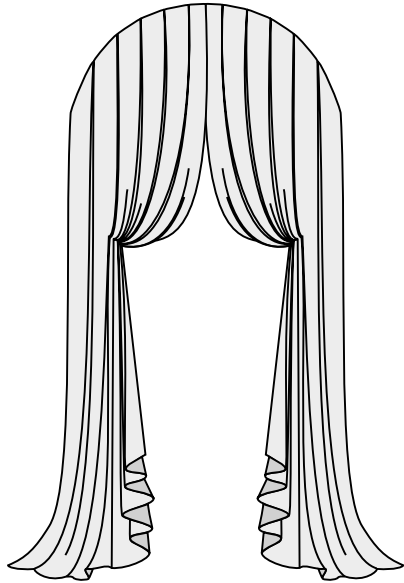

~ Italian Strung Arch ~

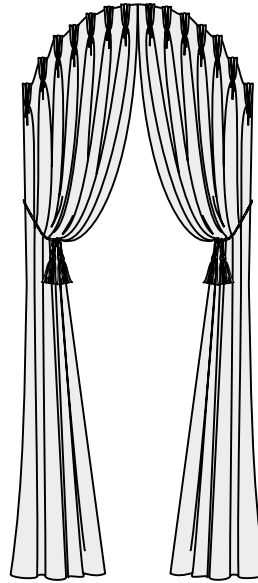

~ Pinch Pleat ~

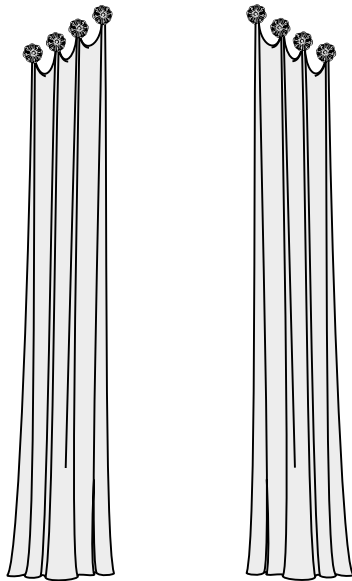

~ Scalloped ~

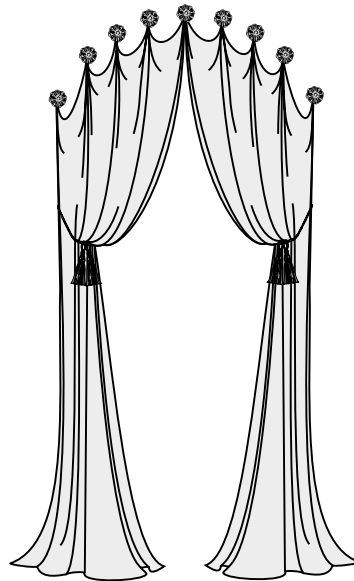

~ Scalloped Arch ~

Drapery Designs

| Arched and Raised |

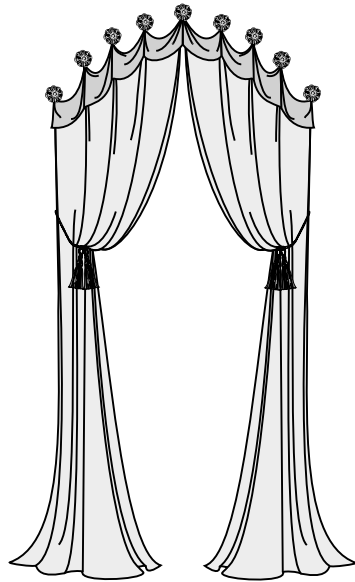

~ Scalloped Arch w/Cuff ~

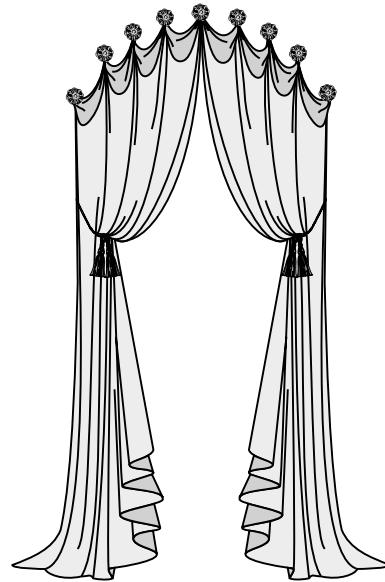

~ Scalloped Arch w/Turned Cuff ~

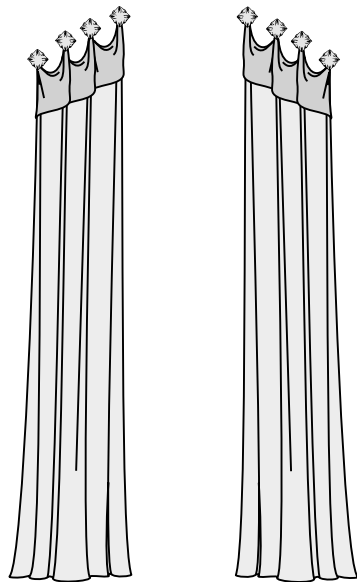

~ Scalloped w/Large Cuff ~

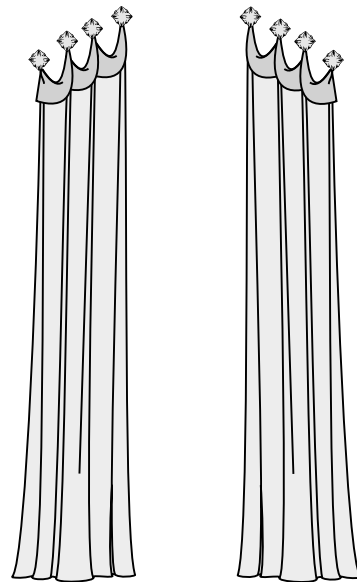

~ Scalloped w/Small Cuff ~

Drapery Designs

| Café Curtains |

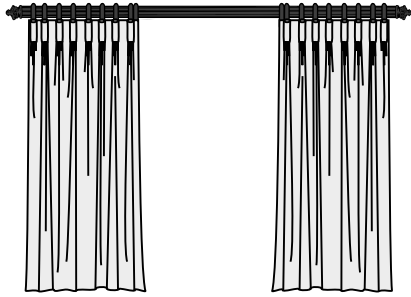

~ Café Cartridge Pleat ~

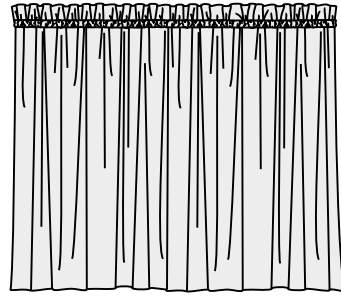

~ Café Curtain Closed ~

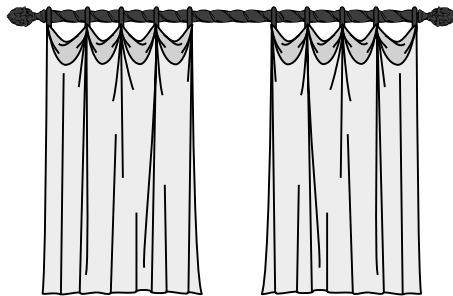

~ Café Curtain w/Cuffs ~

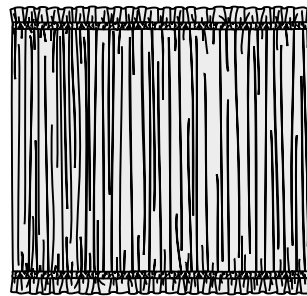

~ Café Curtain w/Ruffle Heading ~

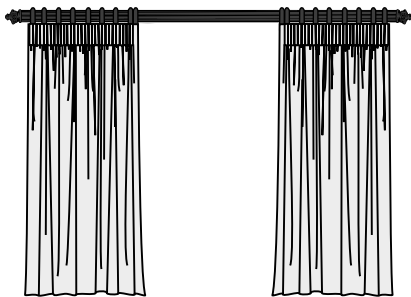

~ Café Pencil Pleat ~

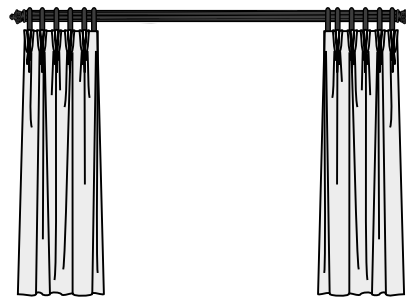

~ Café Pinch Pleat ~

Drapery Designs

| Pleated Headings |

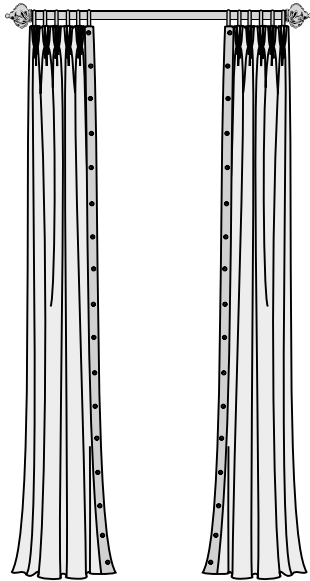

~ Button Lead Edge ~

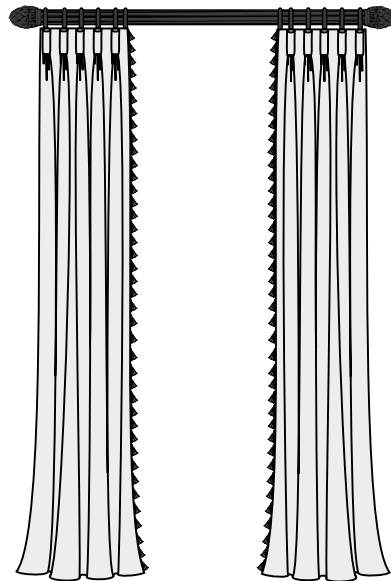

~ Cartridge Pleat ~

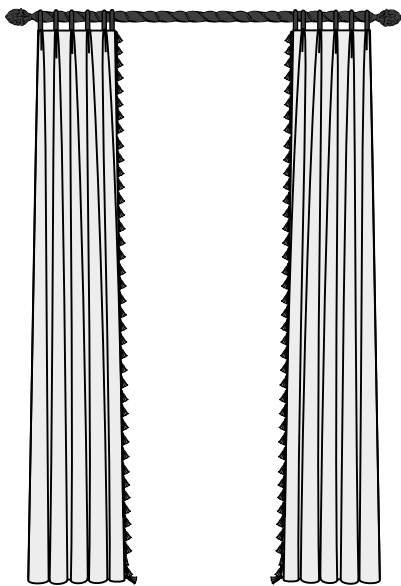

~ Euro Pleat ~

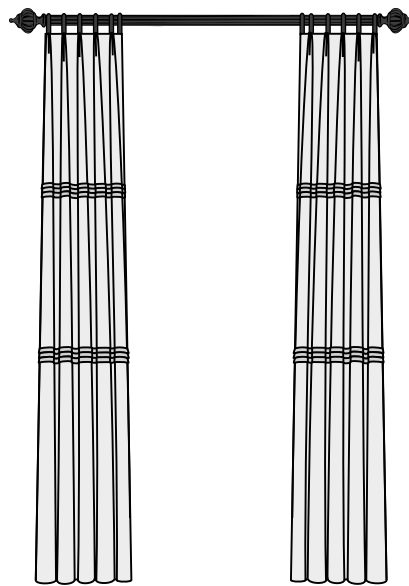

~ Euro Pleat w/Tucks ~

Drapery Designs

| Pleated Headings |

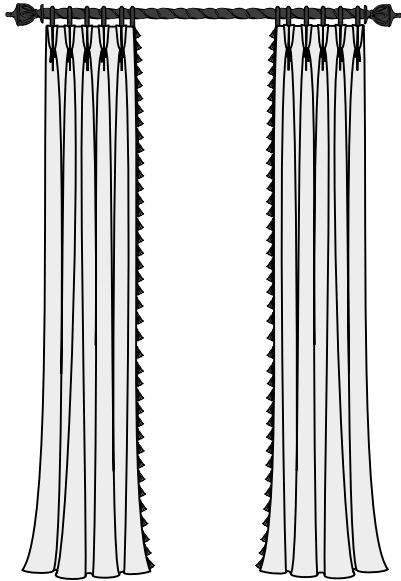

~ Fan Pleat ~

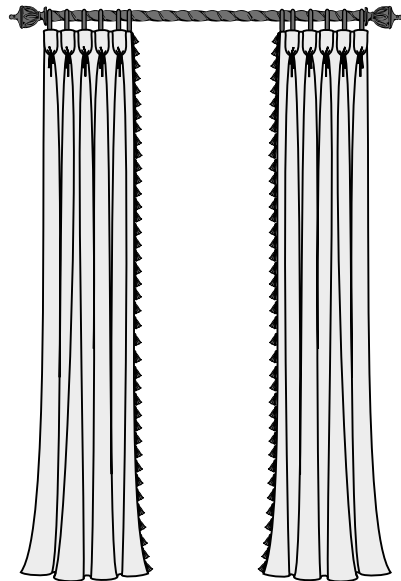

~ Goblet Pleat ~

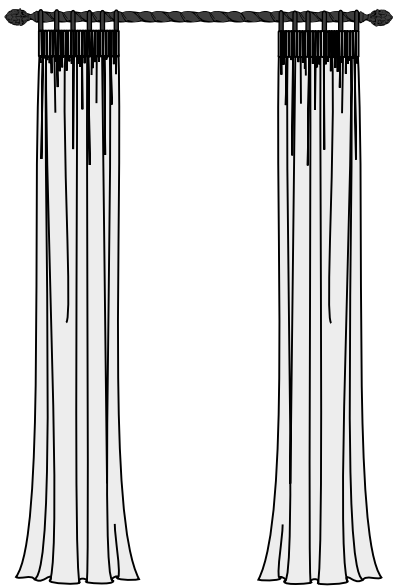

~ Pencil Pleat ~

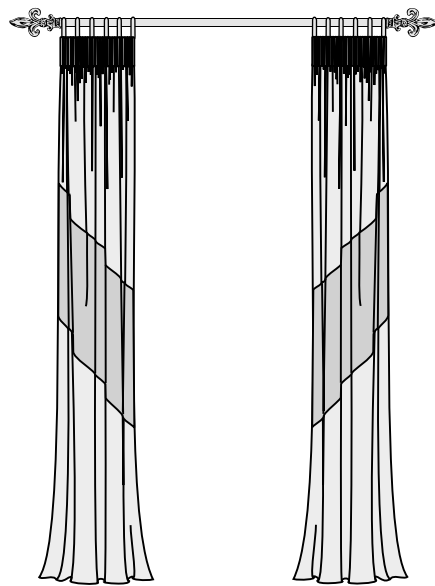

~ Pencil Pleat w/Diagonal Insert ~

Drapery Designs

| Pleated Headings |

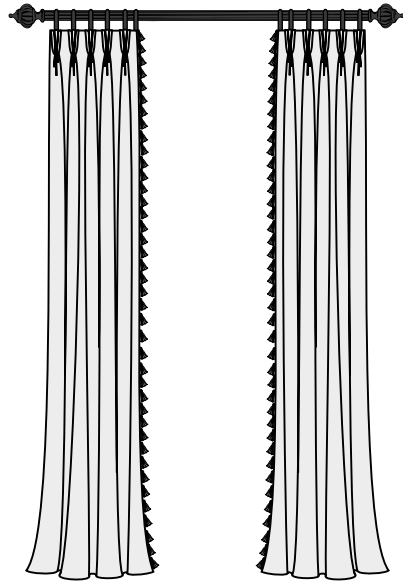

~ Pinch Pleat ~

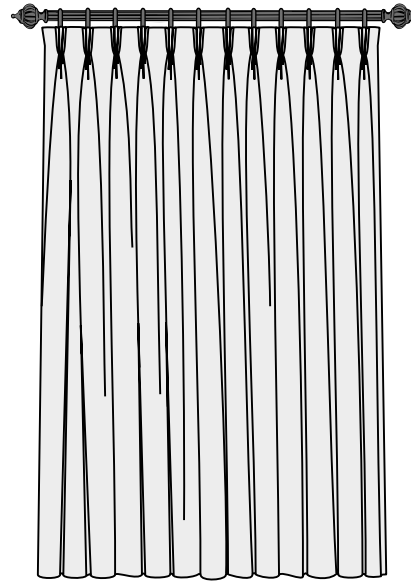

~ Pinch Pleat (Closed) ~

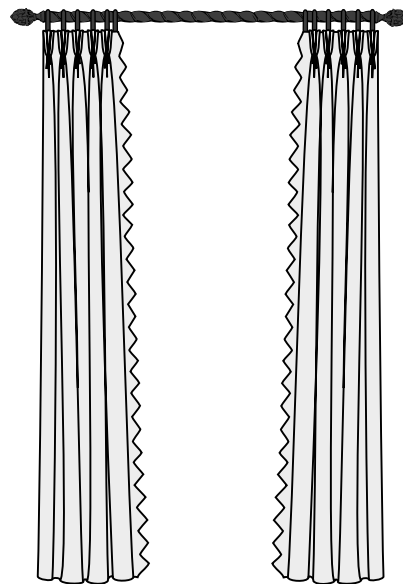

~ Pinch Pleat w/Pointed Lead Edge ~

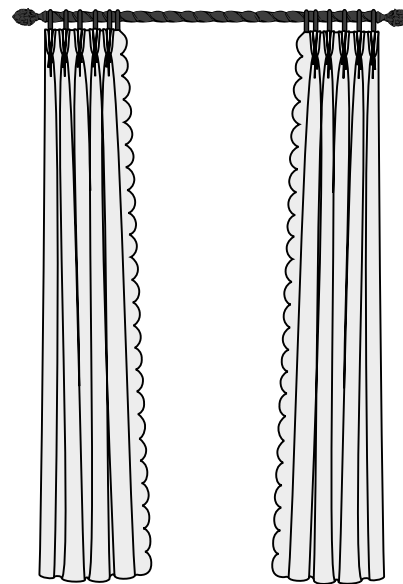

~ Pinch Pleat w/Scalloped Lead Edge ~

Drapery Designs

| Ruched Headings |

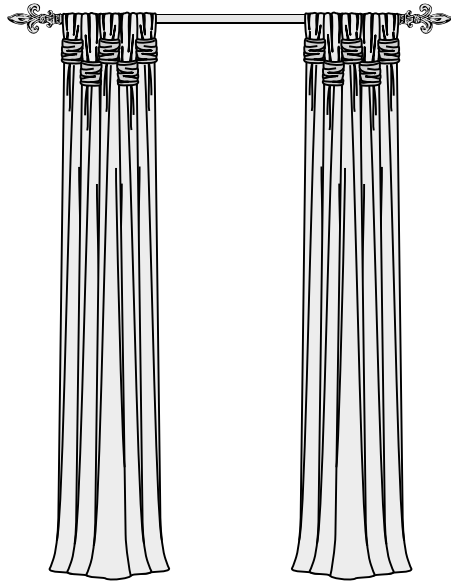

~ Basket Weave ~

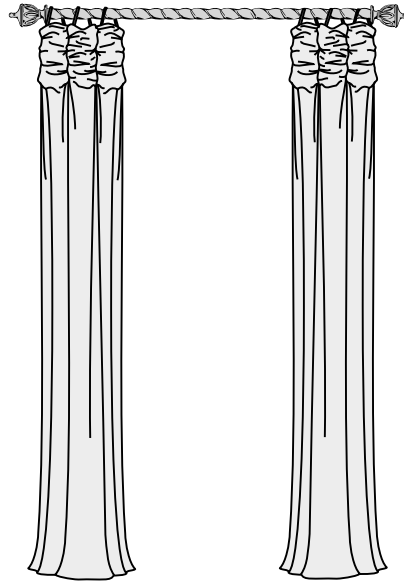

~ Loose Ruche ~

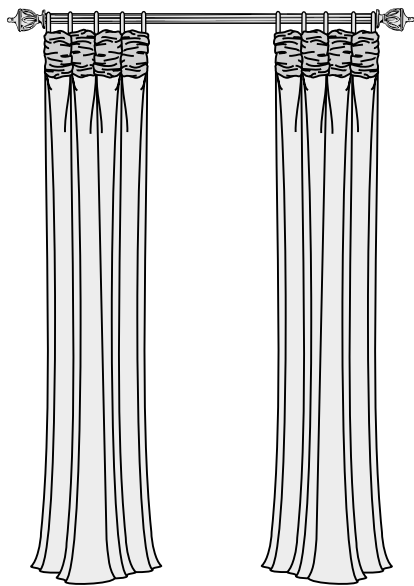

~ Ruche Top ~

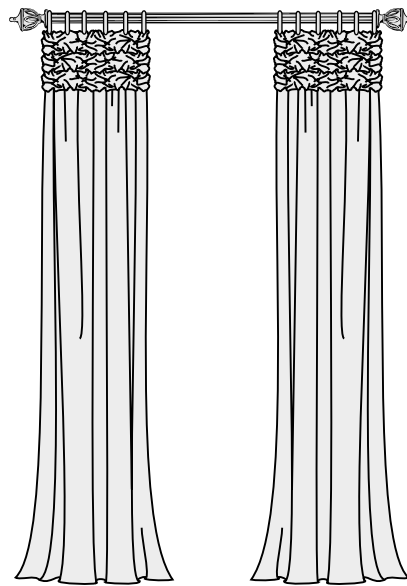

~ Ruched Cuff Triple Layers ~

Draperies Designs

| Ruched Headings |

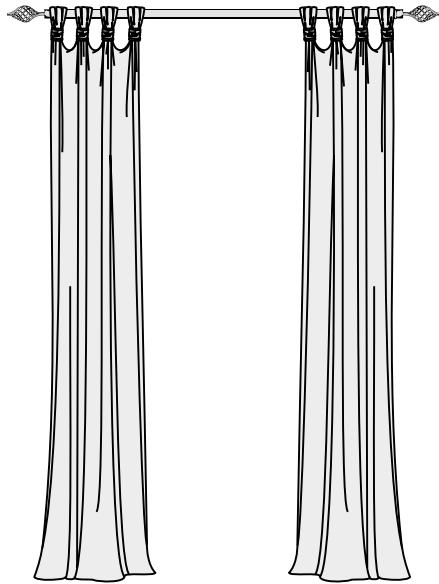

~ Shirred Tab w/Ruche Band ~

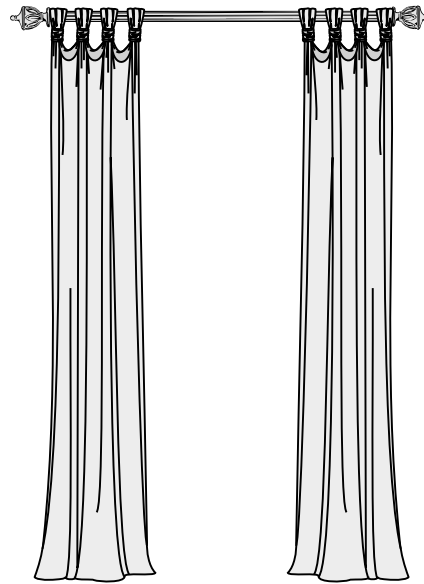

~ Shirred Tab w/Ruche Band ~
and Cuff

Draperies Designs

| Scalloped and Cuffed |

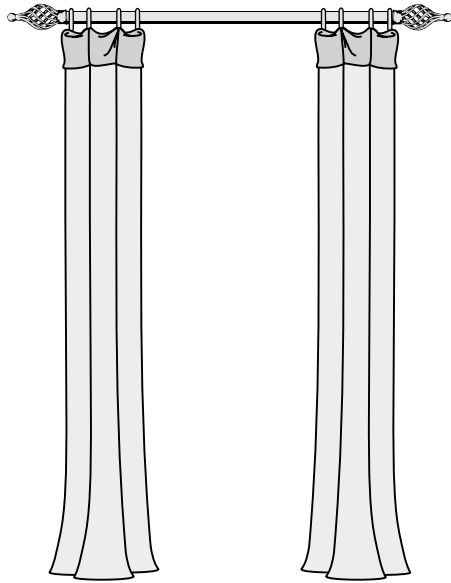

~ Cuffed Top ~

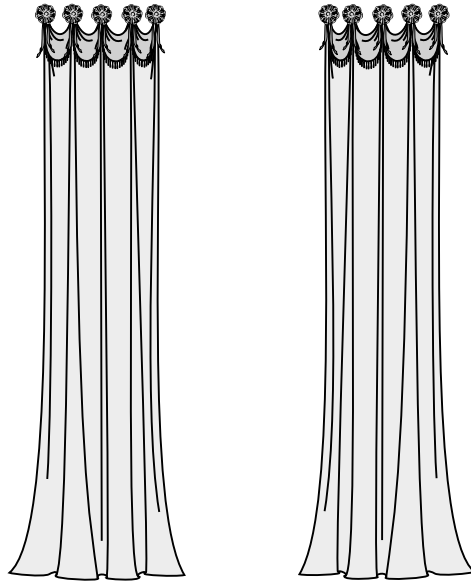

~ Cuff-Top Panel ~

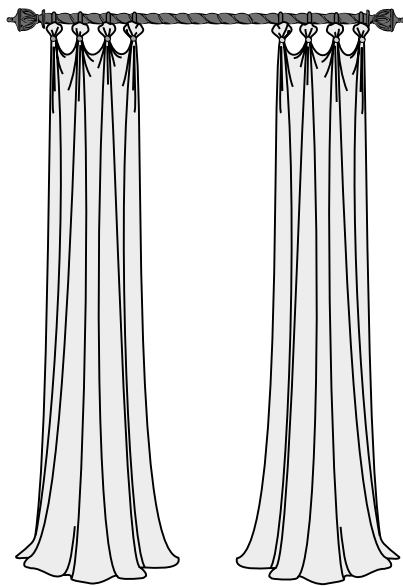

~ Julie Anne Panels ~

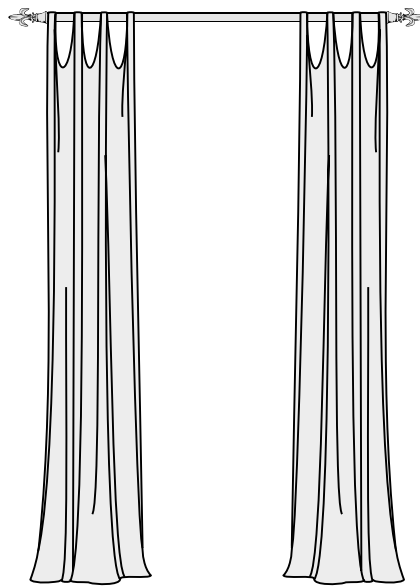

~ Scallop Tab ~

Drapery Designs

| Scalloped and Cuffed |

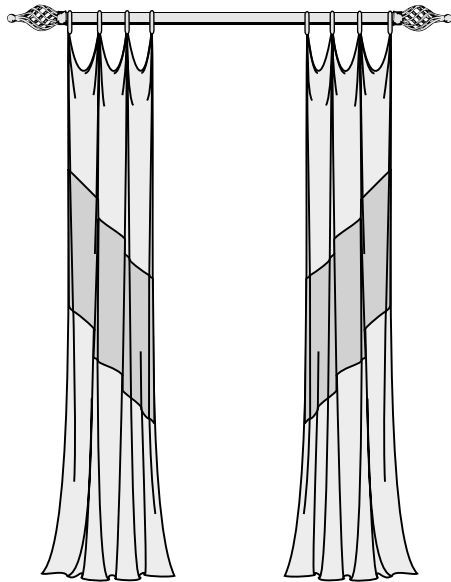

~ Scalloped w/Diagonal Insert ~

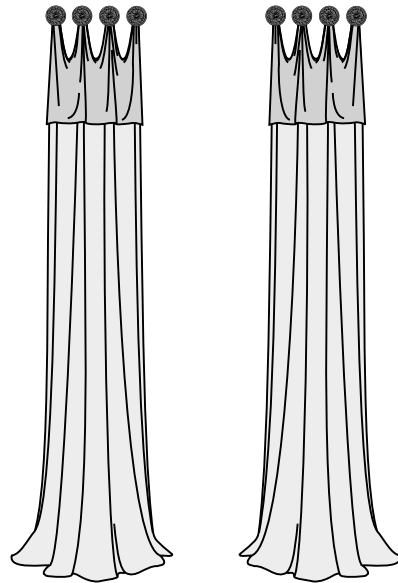

~ Scalloped w/Valance ~

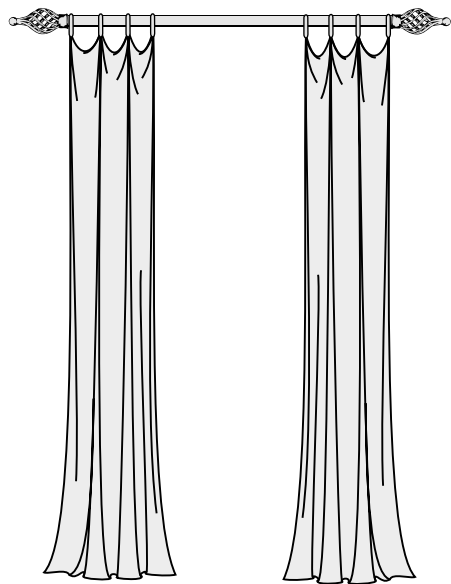

~ Slouched Sheers ~

Drapery Designs

| Shirred Headings |

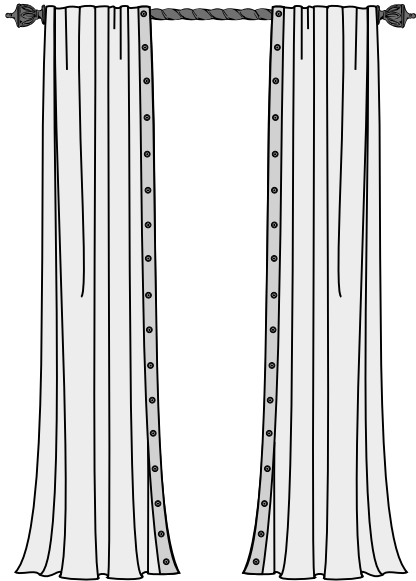

~ Button Lead Edge ~

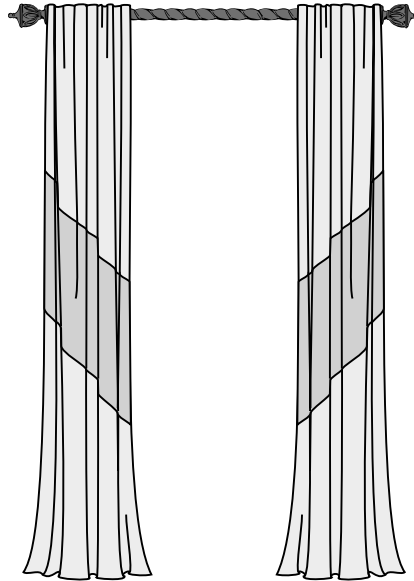

~ Diagonal Insert ~

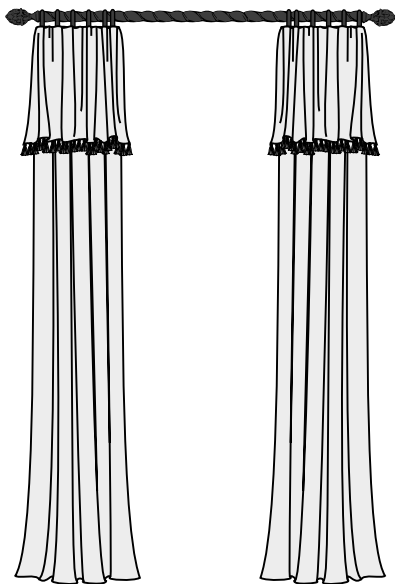

~ Inverted Pleat w/Gathered Flip ~

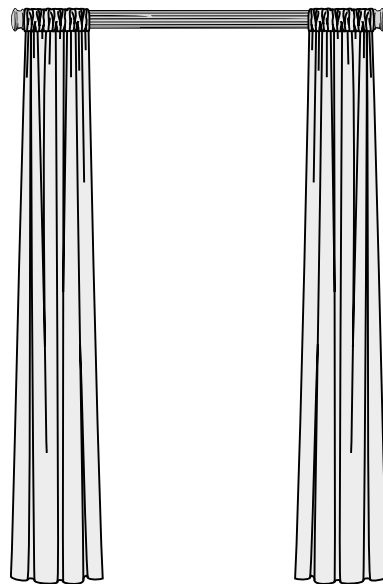

~ Rod Pocket ~

Draperies Designs

| Shirred Headings |

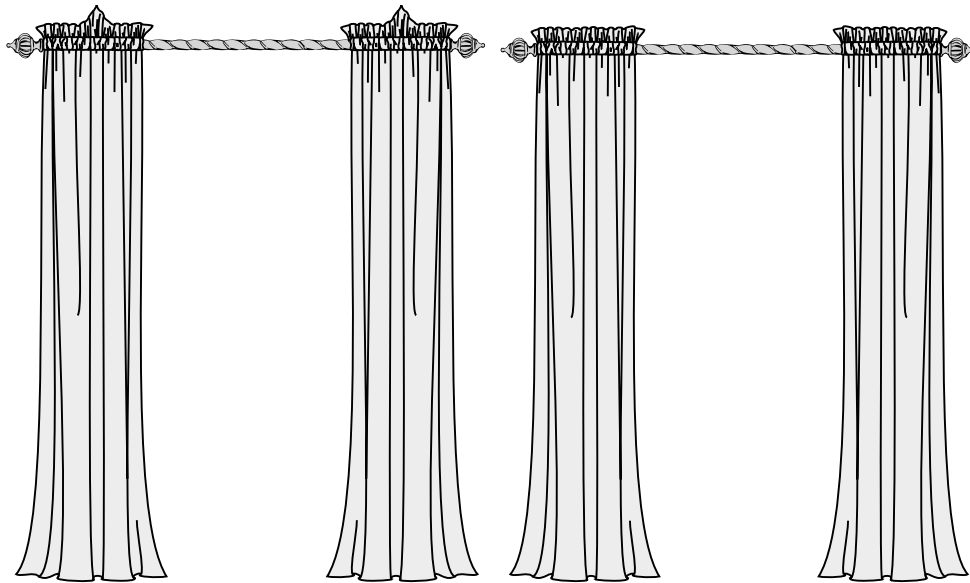

~ Rod Pocket w/Pointed Heading ~

~ Rod Pocket w/Ruffled Heading ~

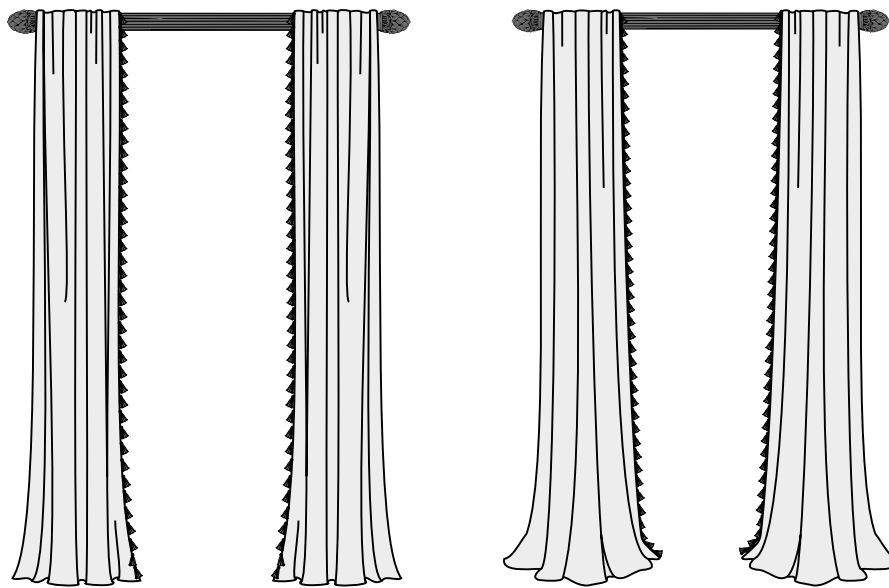

~ Shirred Panel ~

~ Shirred Panel ~

Drapery Designs

| Tailored |

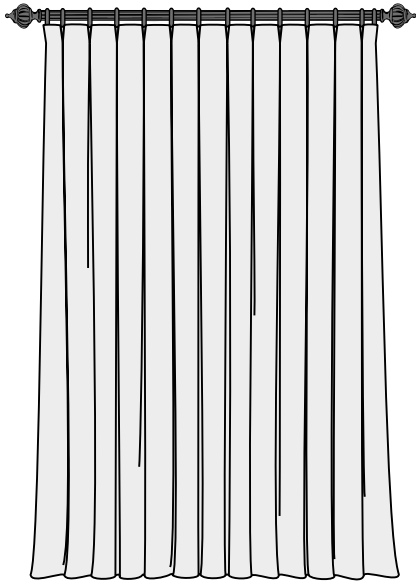

~ Closed Panel ~

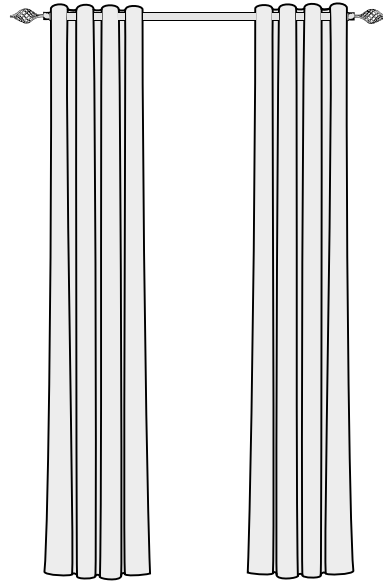

~ Grommet Panel ~

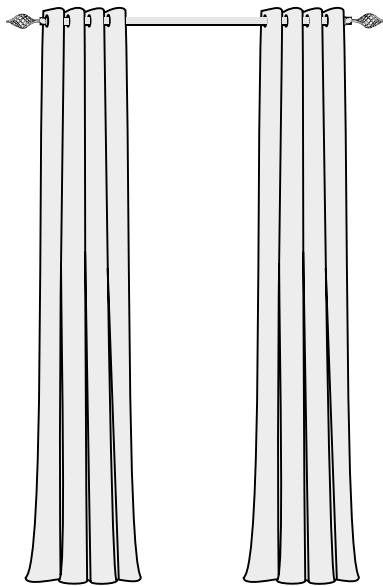

~ Grommet Panel ~

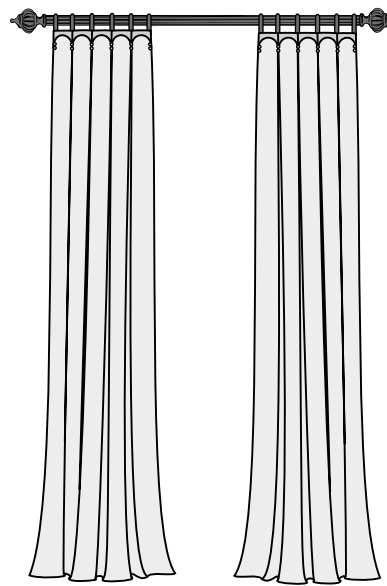

~ Liberty Header ~

Drapery Designs

| Tailored |

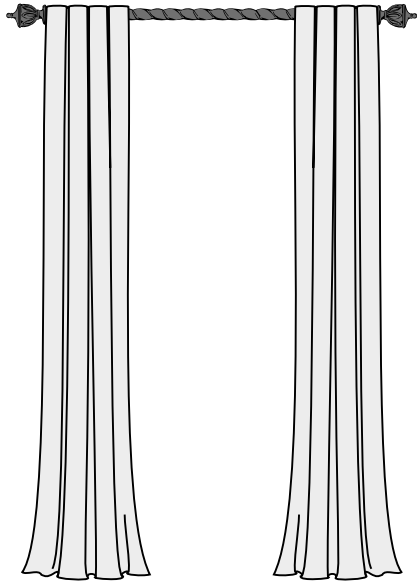

~ Pleated Panel ~

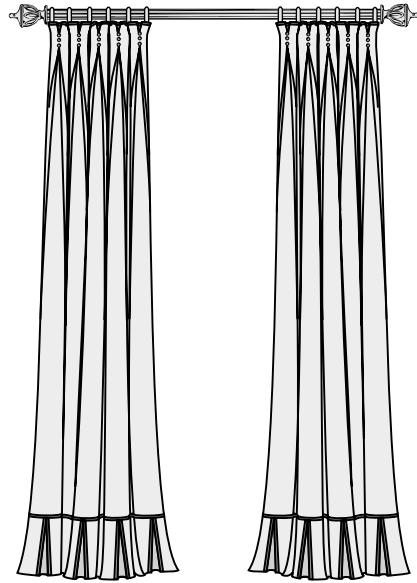

~ Poplar Grove Panels ~

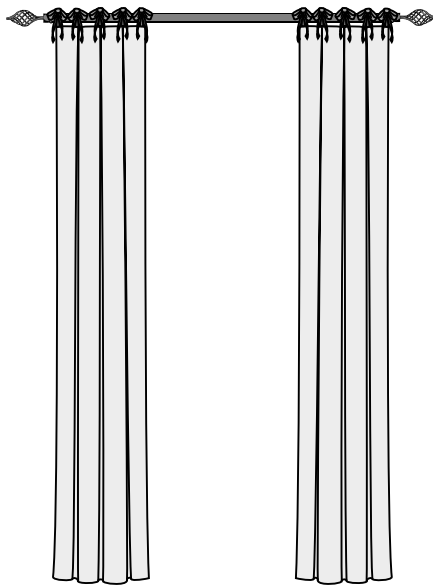

~ Tie Panel ~

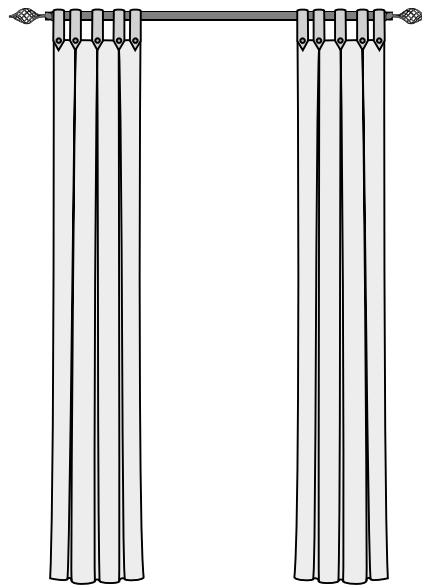

~ Tie Panel ~

Drapery Designs

| Tied Back |

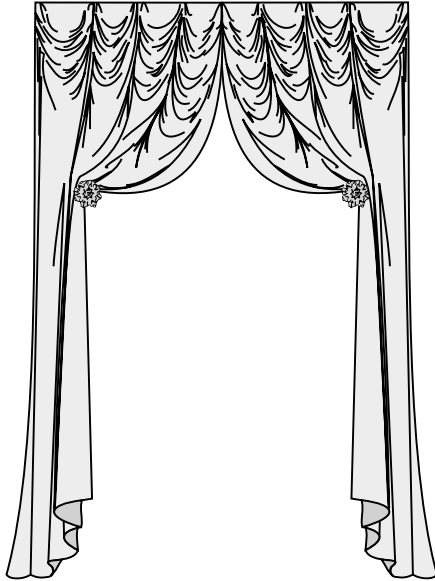

~ Austrian Tied Back ~

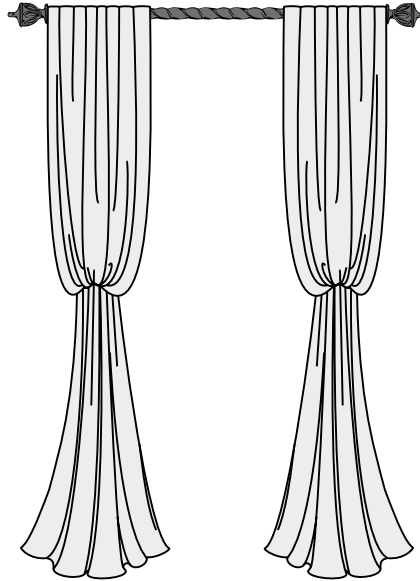

~ Bishop Sleeve ~

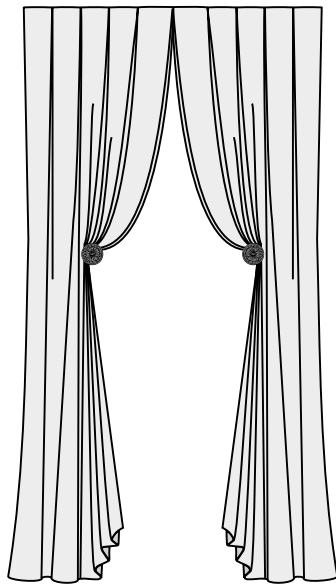

~ Box Pleated Tied Back ~

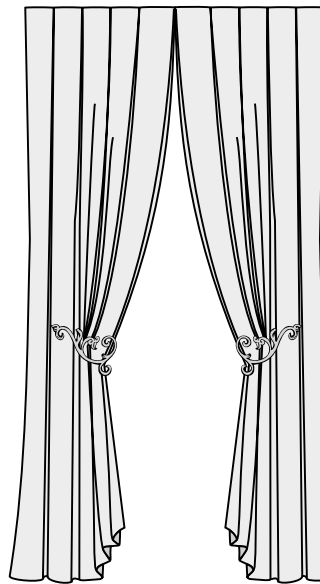

~ Box Pleated Tied Back Low ~

Drapery Designs

| Tied Back |

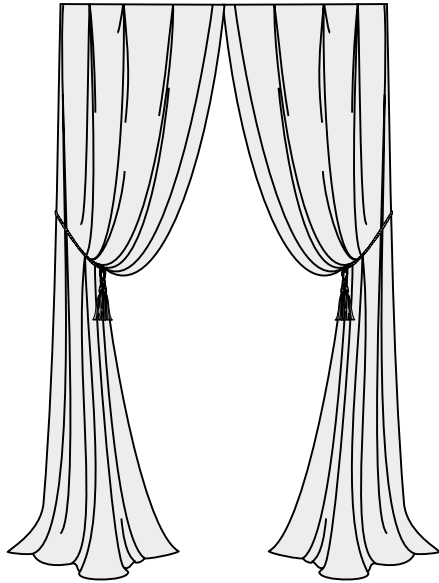

~ Box Pleated Tied Back ~

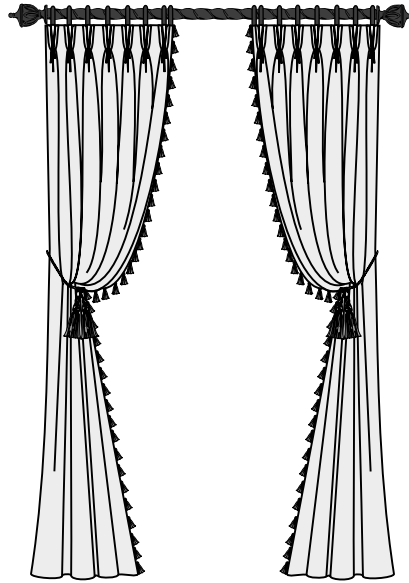

~ Pinch Pleat Low Tie ~

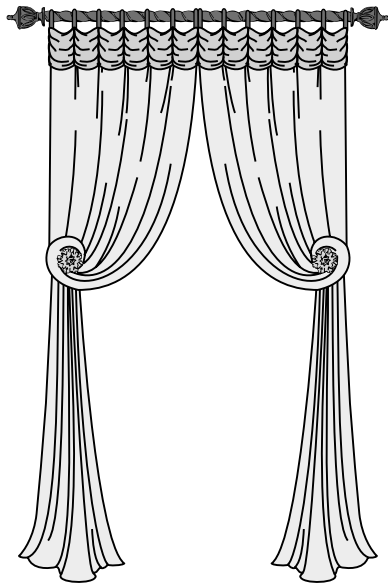

~ Shirred Cuff w/Wrap Tied Back ~

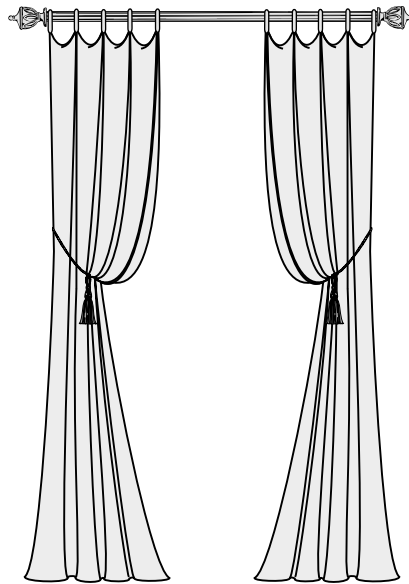

~ Slouched Sheers Tied Back ~

Drapery Designs

| Tied Back |

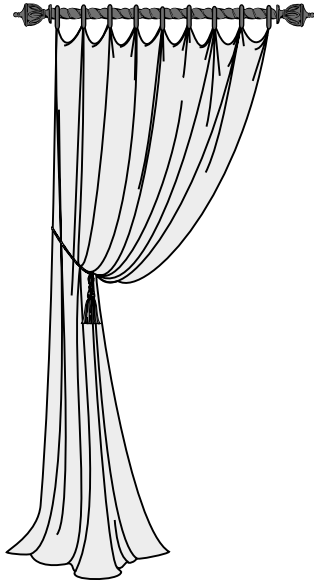

~ Slouched Sheers Tied Back ~

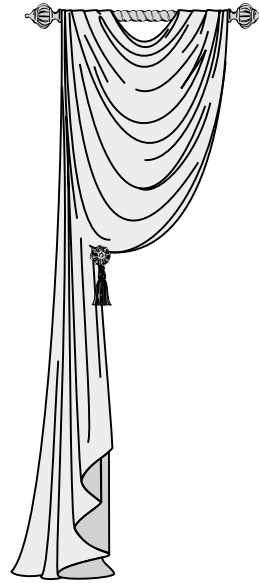

~ Swagged ~

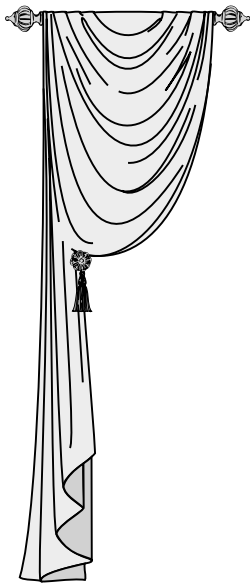

~ Swagged ~

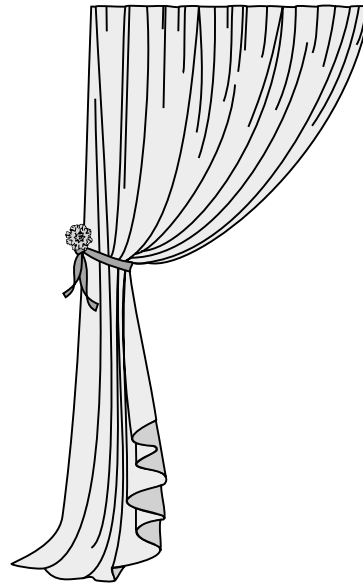

~ Tie Back Cascade ~

Draperies Designs

| Tied Back |

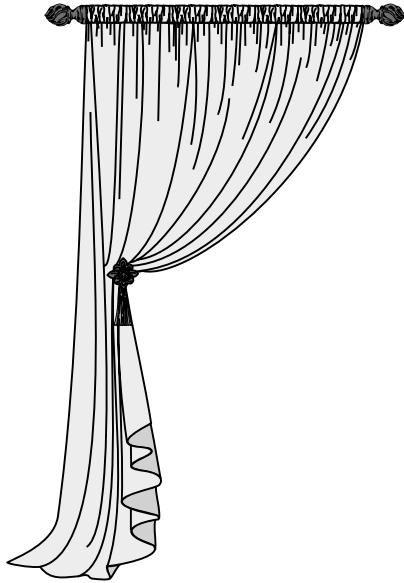

~ Tie Back Cascade w/Rod Pocket ~

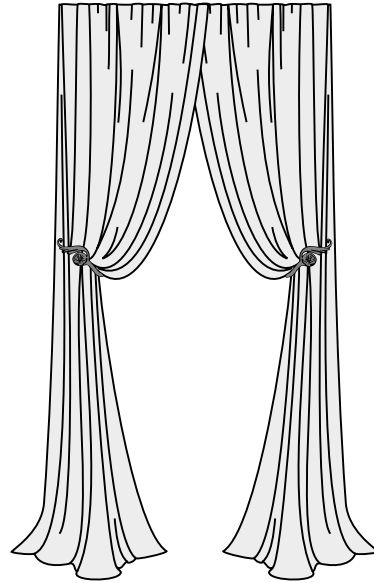

~ Tied Back (Double) ~

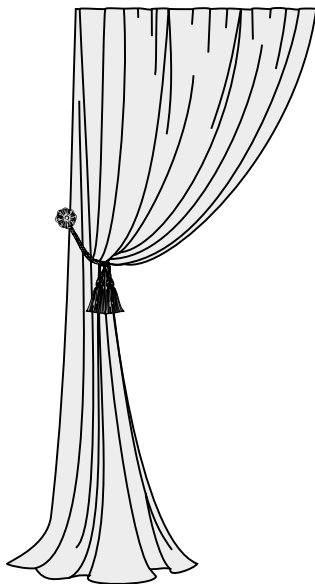

~ Tied Back (Single) ~

Drapery Designs

|Tuxedo and Italian Stringing|

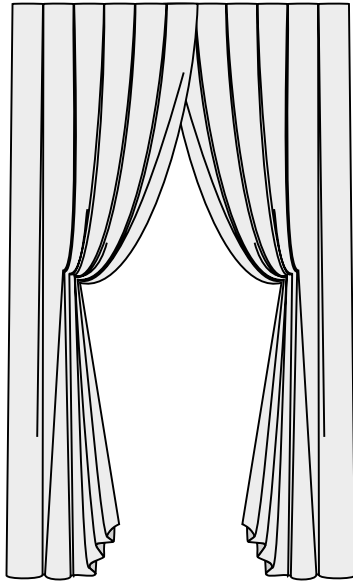

~ Box Pleat w/Italian Stringing ~

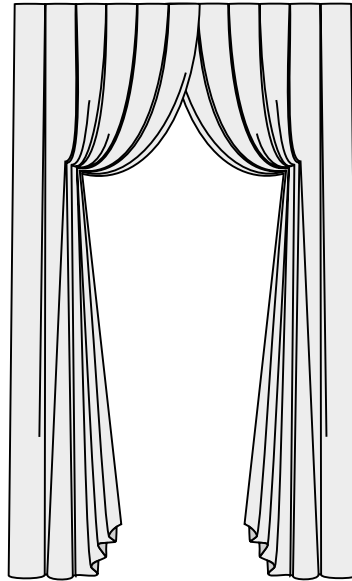

~ Box Pleat w/Italian Stringing ~

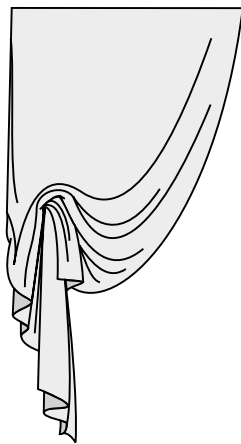

~ Pelmet ~

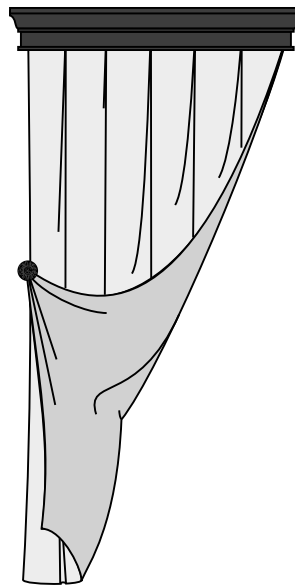

~ Tuxedo Box Pleat ~

Drapery Designs

|Tuxedo and Italian Strung|

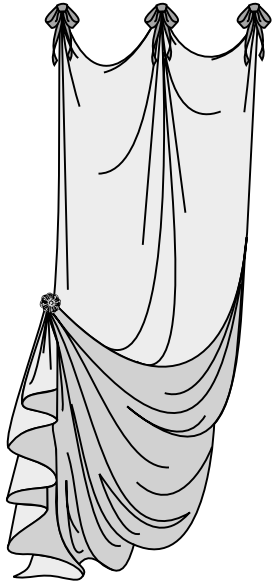

~ Tuxedo Scalloped ~

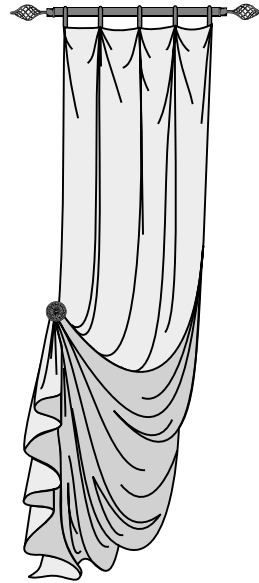

~ Tuxedo Scalloped ~

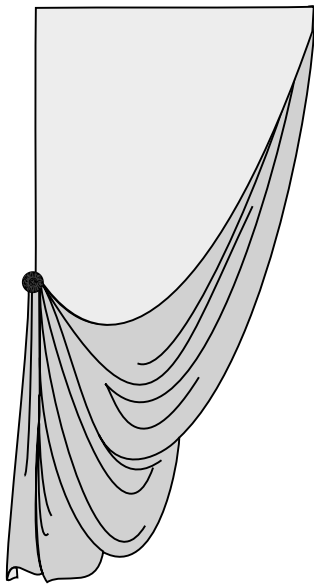

~ Tuxedo (Single) ~

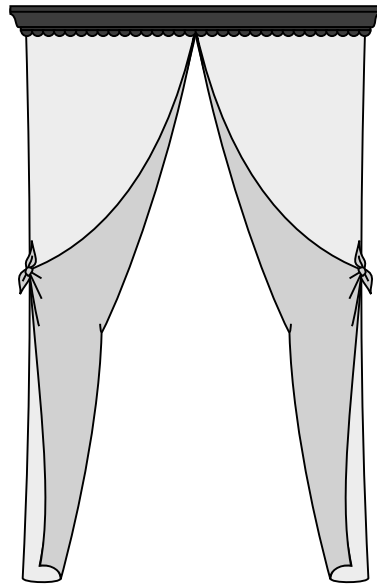

~ Tuxedo w/Ties ~

Drapery Designs

| Unique Heading |

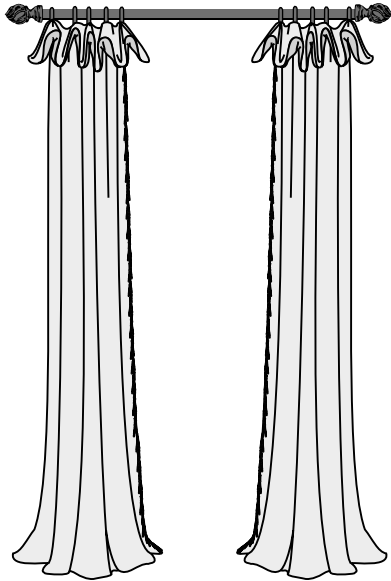

~ Floppy Top Panel ~

Style:

Fabric
— Shades



Fabric Shades

| Balloons |

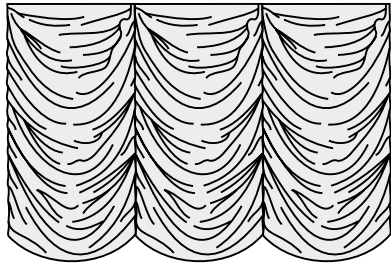

~ Austrian Shade ~

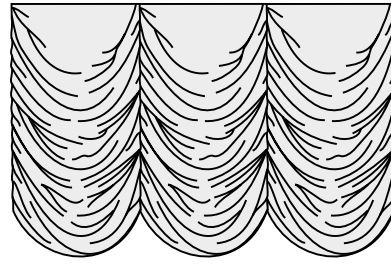

~ Austrian Shade ~

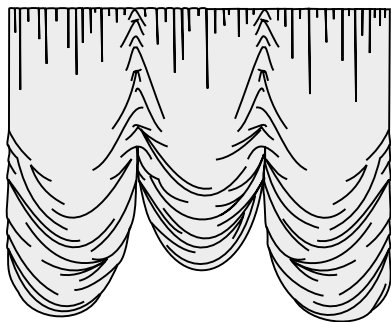

~ Austrian Opera Shade ~

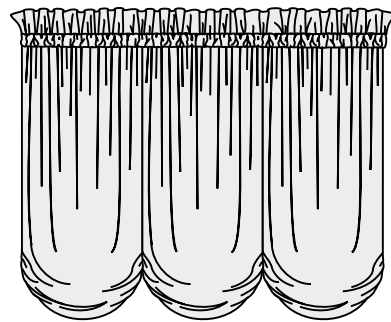

~ Balloon Rod Pocket w/Heading ~

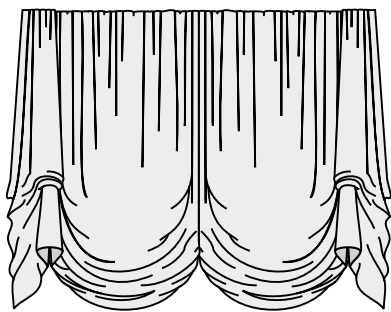

~ Balloon w/Horns ~

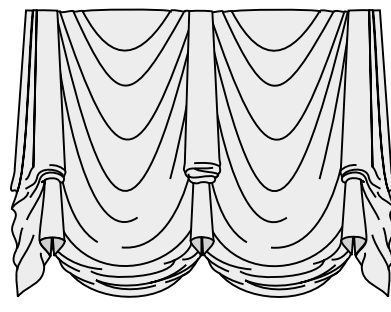

~ Empire Balloon ~

Fabric Shades

| Balloons |

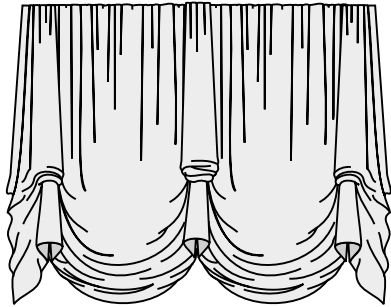

~ Empire Balloon ~

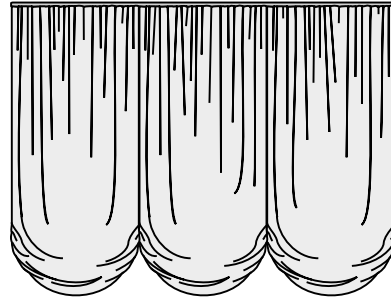

~ Gathered Balloon ~

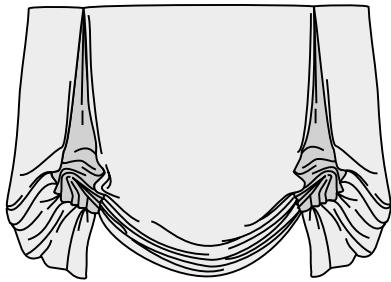

~ London Shade ~

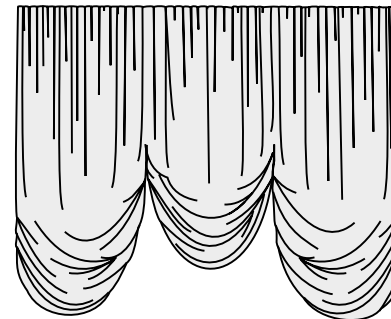

~ Opera Balloon ~

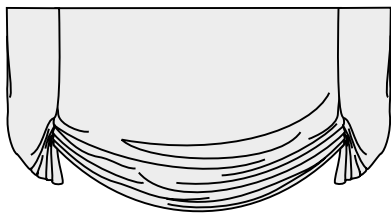

~ Pleated Butterfly Balloon ~

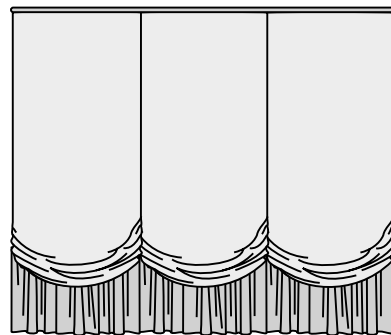

~ Variety Balloon w/Ruffle ~

Fabric Shades

| Balloons |

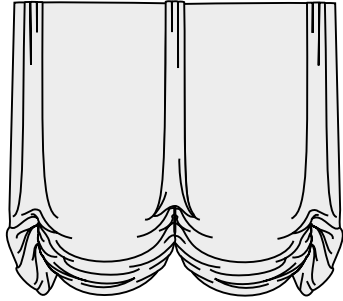

~ Variety Balloon w/Pleat ~

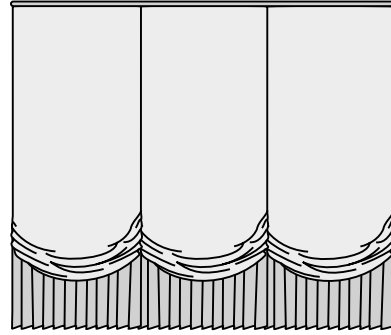

~ Variety Balloon w/Pleated Ruffle ~

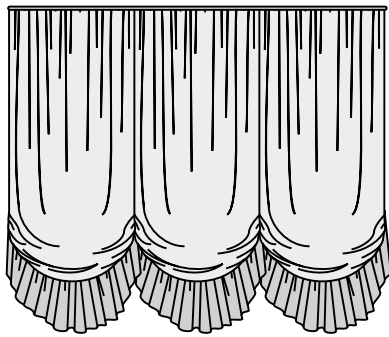

~ Variety Balloon w/Ruffle ~

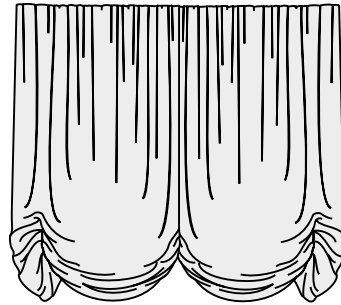

~ Variety Balloon w/Wings ~

Fabric Shades

| Romans |

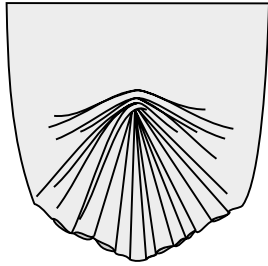

~ Fan Roman Shade ~



~ Hobbled Roman Shade ~

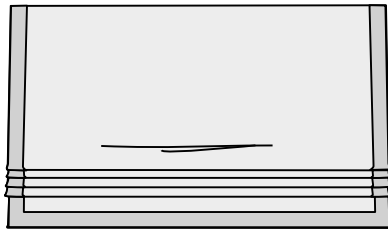

~ Plain Banded Roman ~



~ Plain Roman ~

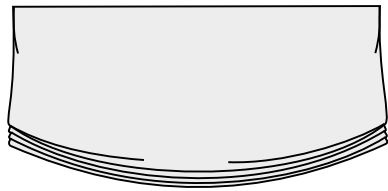

~ Relaxed Roman Shade ~

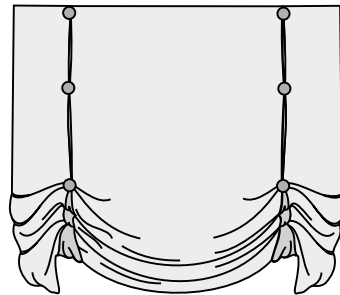

~ Roman w/ Buttoned Insert ~

Fabric Shades

| Romans |

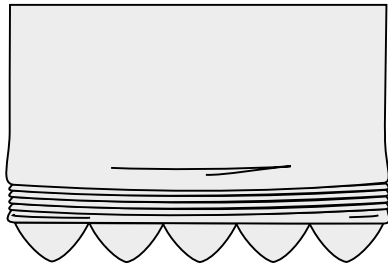

~ Roman w/Pointed Edge ~

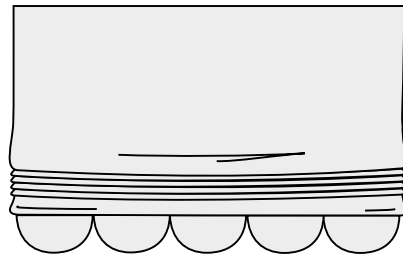

~ Roman w/Scalloped Edge ~

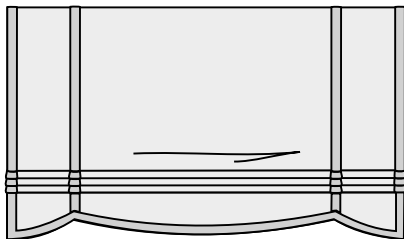

~ Roman w/Shaped Bottom ~
and Banding

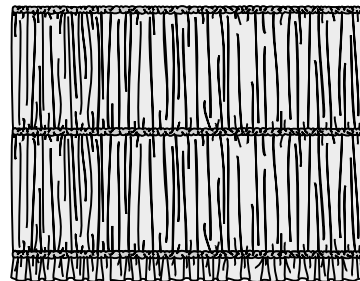

~ Shirred Roman ~

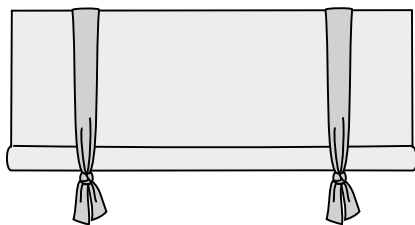

~ Stagecoach Roman ~
Rolled Forward w/Ties

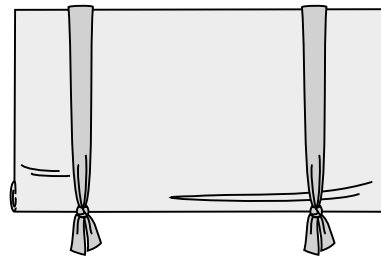

~ Stagecoach Roman w/Ties ~

Fabric Shades

| Romans |

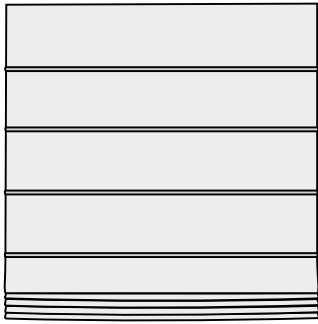

~ Tucked Front Roman Shade ~

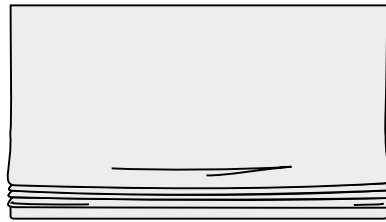

~ Variety Roman Shade ~

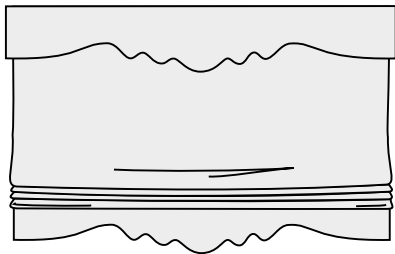

~ Variety Roman Shade ~

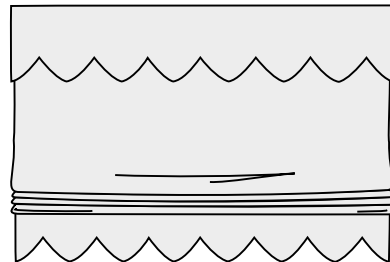

~ Variety Roman Shade ~

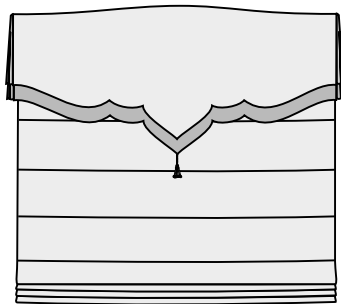

~ Roman w/Valance ~

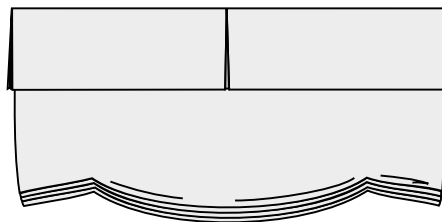

~ Winged Roman Shade ~



Style:

Specialty
— Designs

4



Speciality Designs

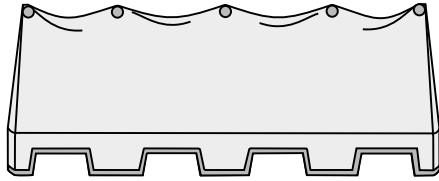

~ Erin Awning ~

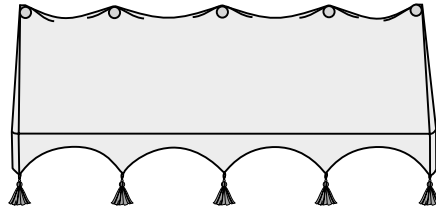

~ Indoor Awning ~

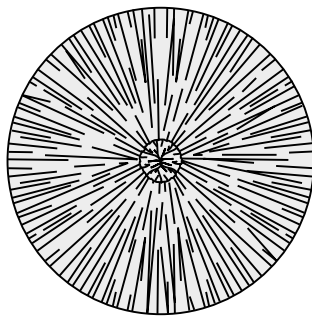

~ Gathered Circle Sunburst ~

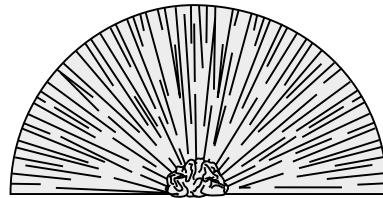

~ Gathered Half Arch Sunburst ~

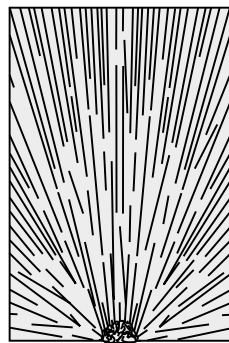

~ Gathered Rectangle Sunburst ~

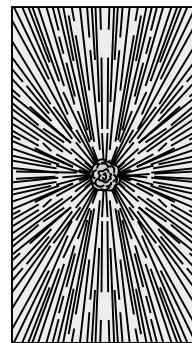

~ Gathered Rectangle Sunburst ~

Speciality Designs

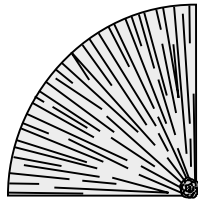

~ Gathered Quarter Arch Sunburst ~

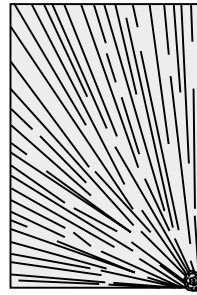

~ Gathered Quarter Sunburst ~

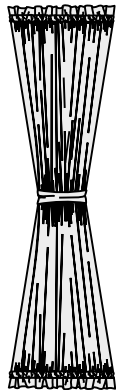

~ Hourglass w/Ruffle Heading ~

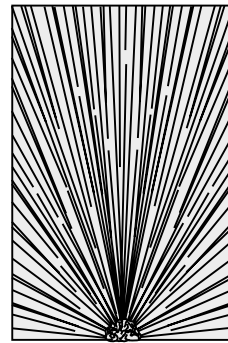

~ Pleated Rectangle Sunburst ~

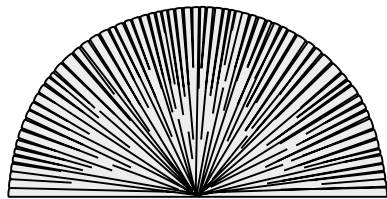

~ Pleated Half Arch Sunburst ~

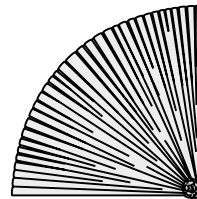

~ Pleated Quarter Arch Sunburst ~



Style:

Swags and
— Valances

5



Swags and Valances

| Arched and Raised |

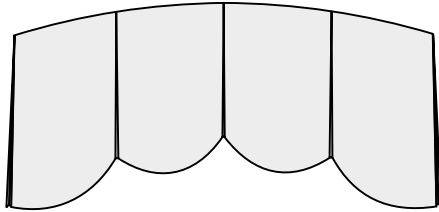

~ Arched Treatment ~
w/Scalloped Box Pleats

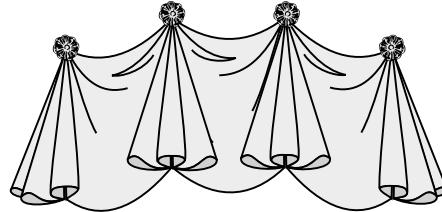

~ Arching Scallop ~

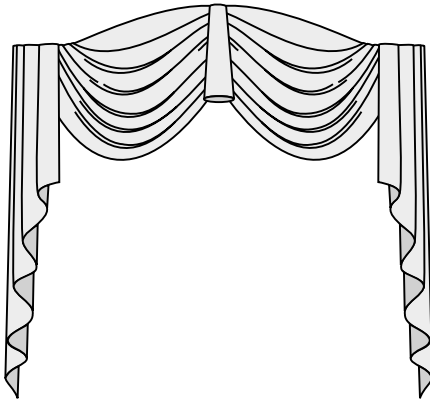

~ Butterfly Swag ~

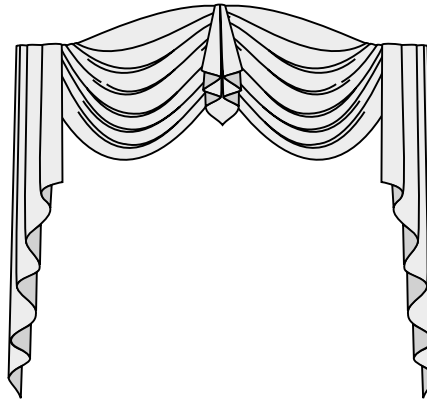

~ Butterfly Swag ~

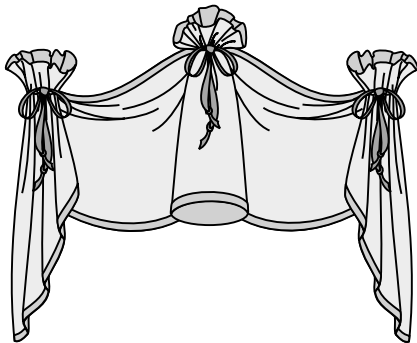

~ Carriage Valance ~

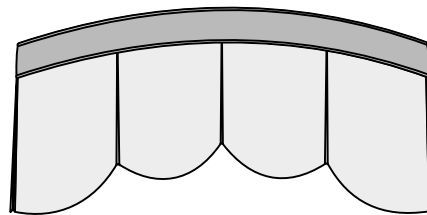

~ Curved Box Valance ~

Swags and Valances

| Arched and Raised |

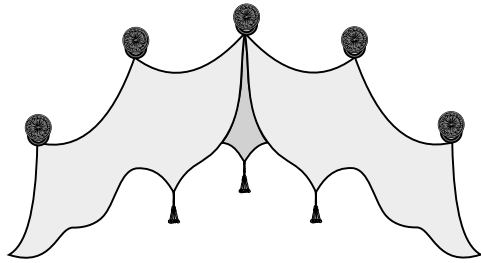

~ Florentine Arched Valance ~

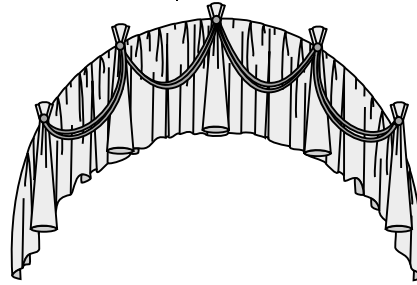

~ Gathered Arch Valance ~

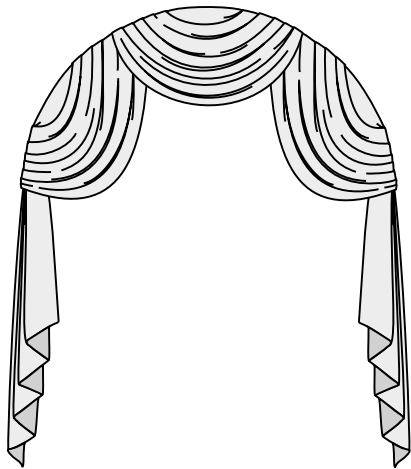

~ Gathered Swags and Cascades ~

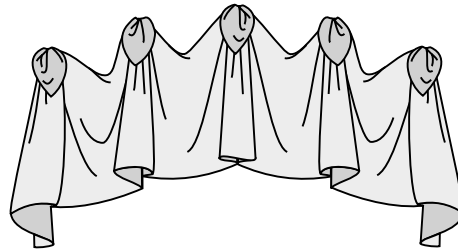

~ Haley Valance ~

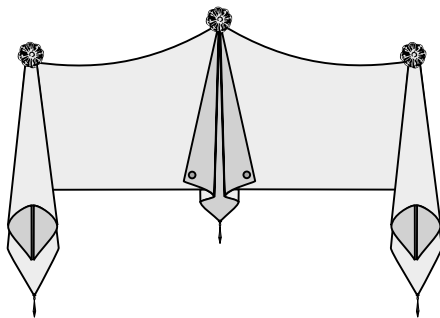

~ Karmen Valance ~

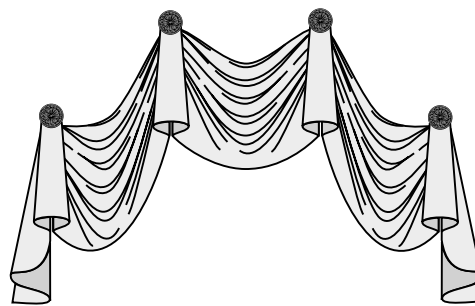

~ Kingston Arched Valance ~

Swags and Valances

| Arched and Raised |

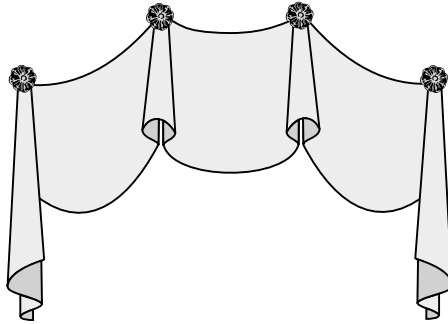

~ Oxford Valance ~

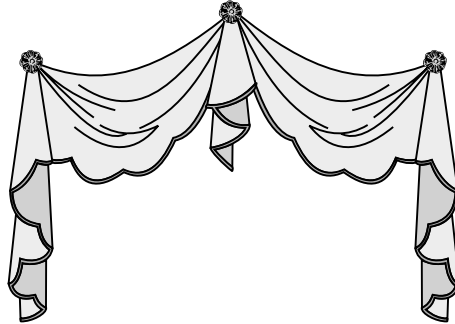

~ Parisian Raised Swag ~

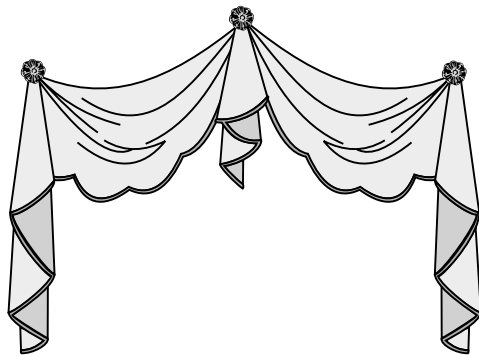

~ Parisian Raised Swag ~

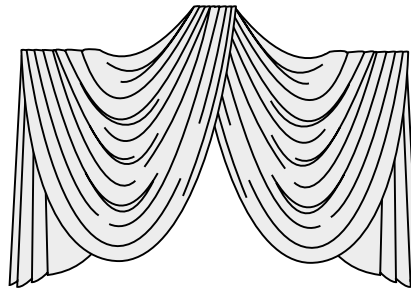

~ Peaked Swag ~

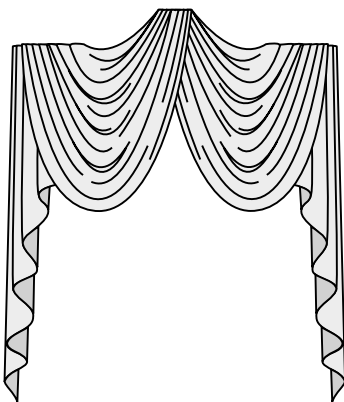

~ Peaked Swag ~

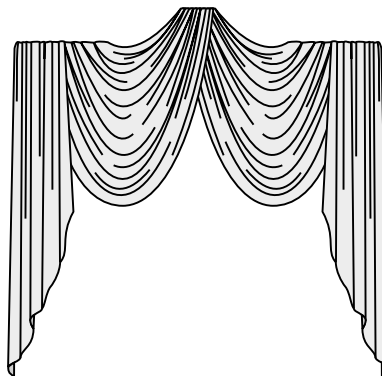

~ Peaked Swag ~

Swags and Valances

| Arched and Raised |

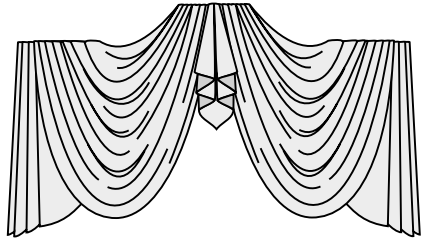

~ Peaked Swag ~

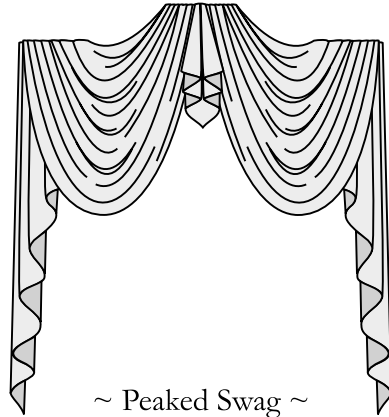

~ Peaked Swag ~

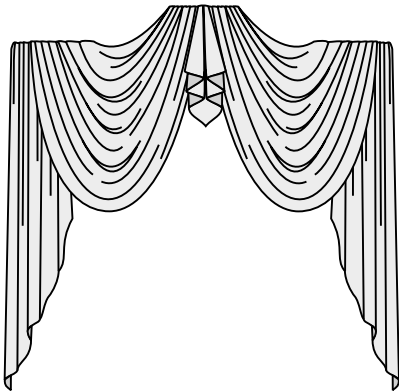

~ Peaked Swag ~

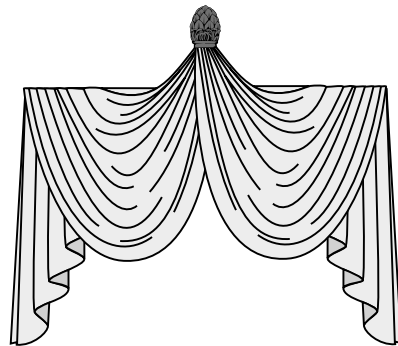

~ Peaked Swag ~

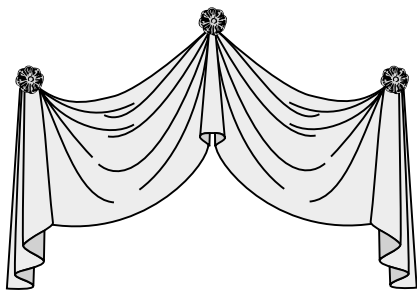

~ Pull-Up Valance ~

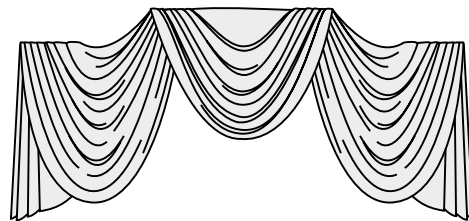

~ Raised Swag ~

Swags and Valances

| Arched and Raised |

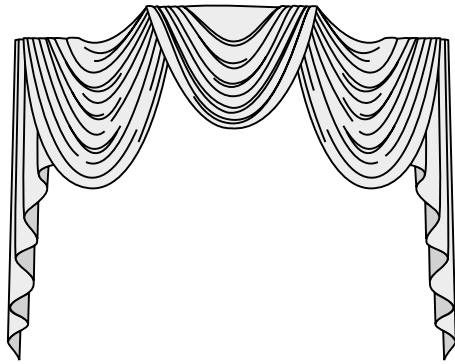

~ Raised Swag ~

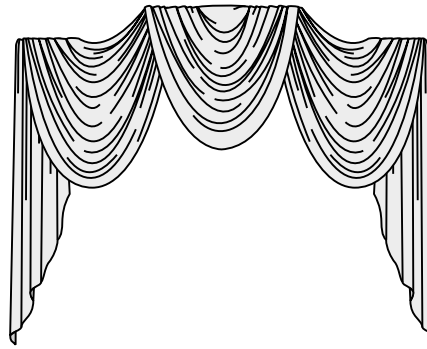

~ Raised Swag ~

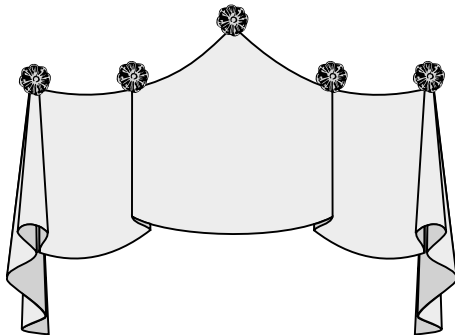

~ Summerhouse Valance ~

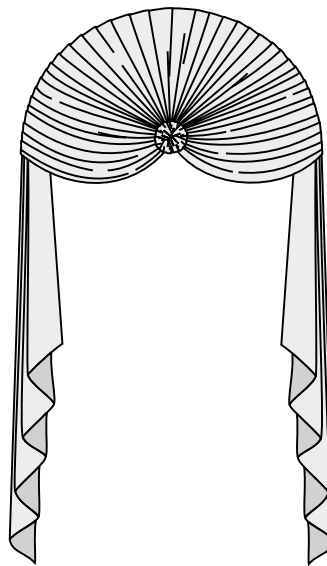

~Sunburst Swag w/Cascades ~

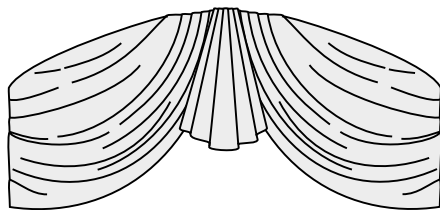

~ Turban Arched Swag ~

Swags and Valances

| Board Mount |

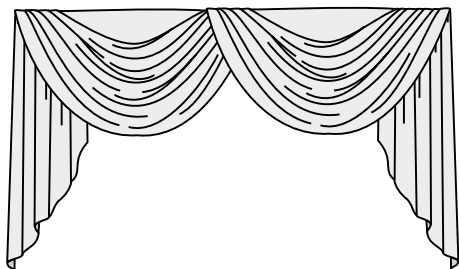

~ Basic Gathered Swag ~

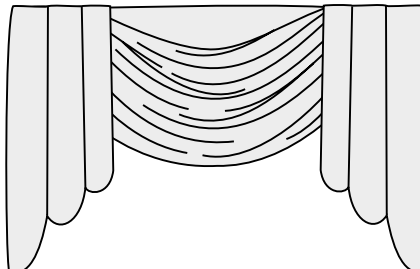

~ Basic Gathered Swag ~

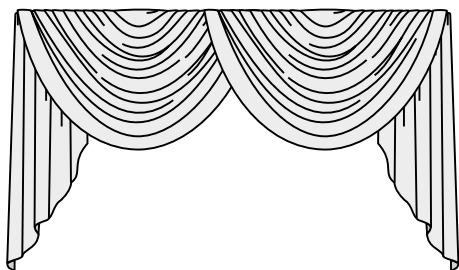

~ Basic Gathered Swag ~

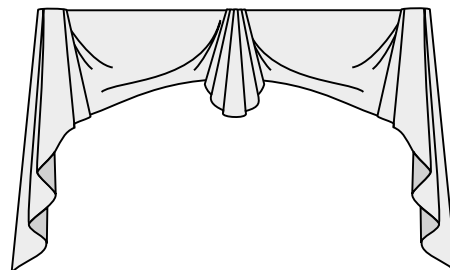

~ Bordeaux Valance ~

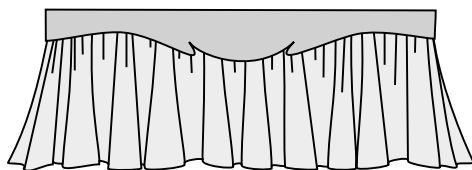

~ Chantilly Valance ~

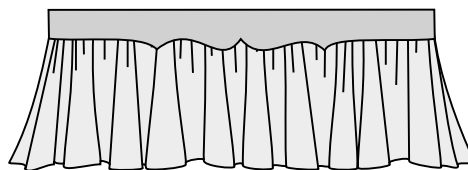

~ Chantilly Valance ~

Swags and Valances

| Board Mount |

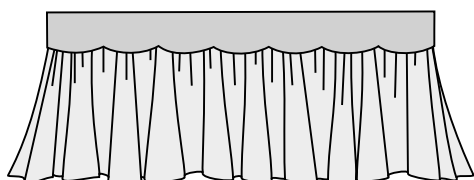

~ Chantilly Valance ~

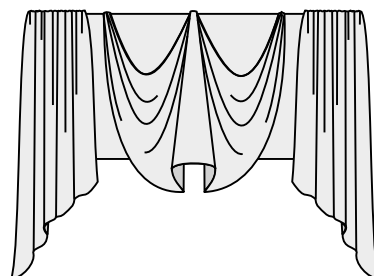

~ Charlsey Valance ~

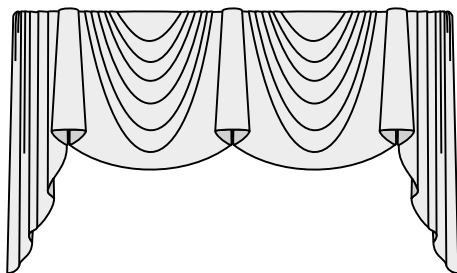

~ Classic Empire Valance ~

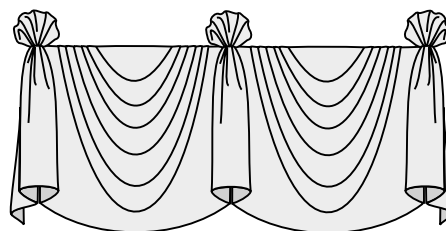

~ Classic Empire Valance ~

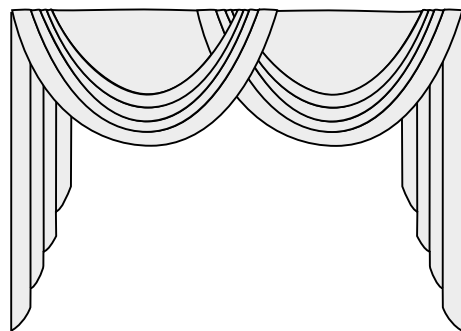

~ Criss-Cross Swag ~

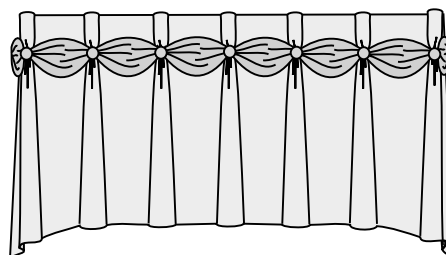

~ Dana Valance ~

Swags and Valances

| Board Mount |

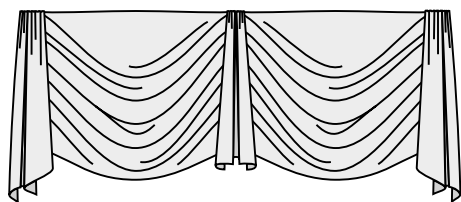

~ Double Shirr Swag ~

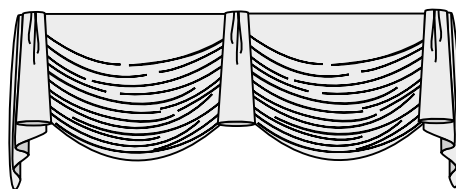

~ Double Shirr Swag ~

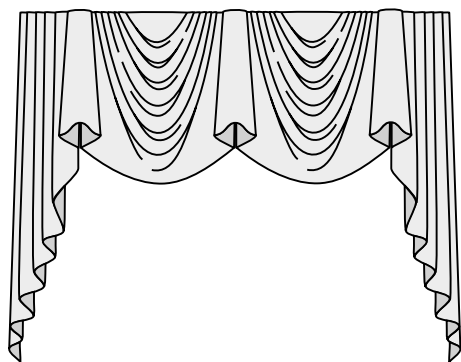

~ Elaborate Empire Valance ~

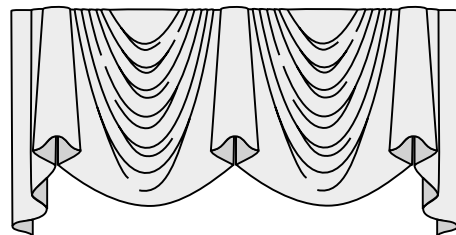

~ Elaborate Empire Valance ~

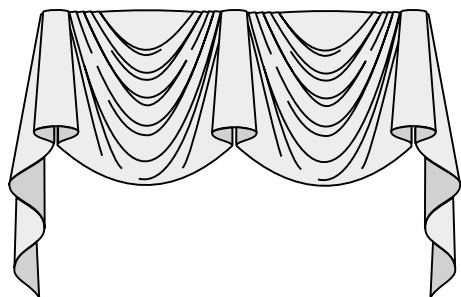

~ Empire Valance ~

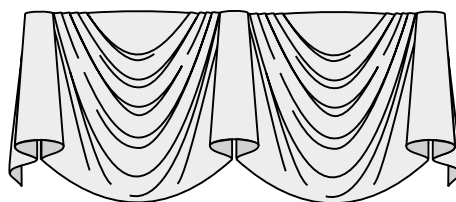

~ Empire Valance ~

Swags and Valances

| Board Mount |

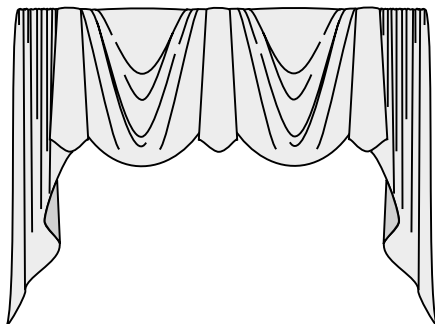

~ Estelle Valance ~

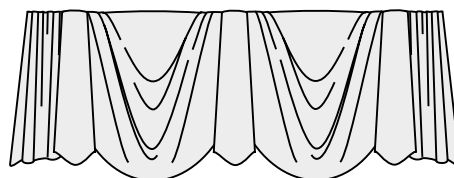

~ Estelle Valance ~

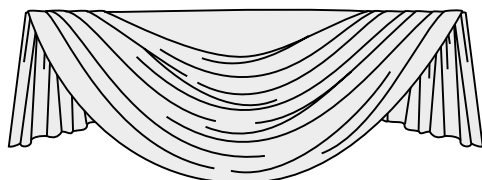

~ Gathered Swag w/Sleeves ~

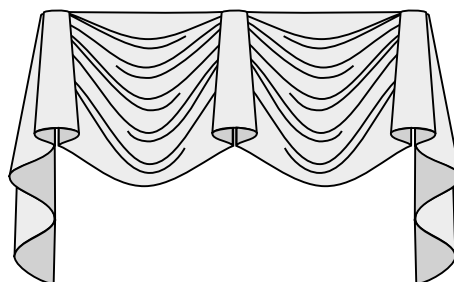

~ Kingston Valance ~

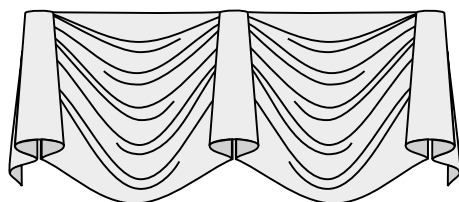

~ Kingston Valance ~

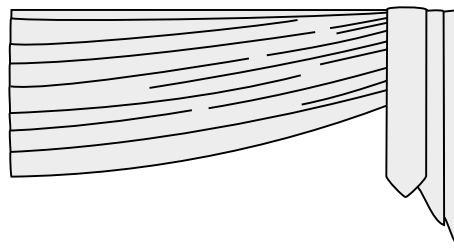

~ Manhattan Valance ~

Swags and Valances

| Board Mount |

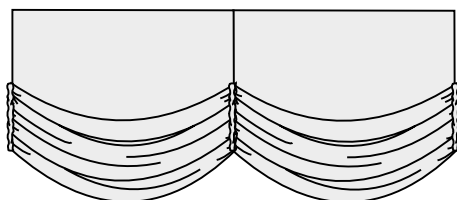

~ Murphy Valance ~

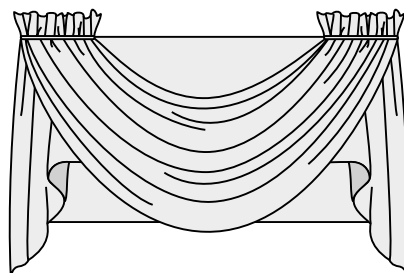

~ Ruched Flange Swag ~

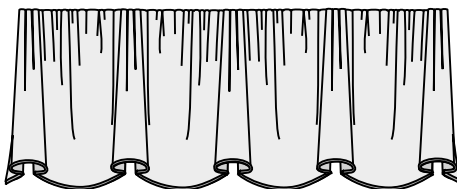

~ Scalloped Valance w/Piping ~

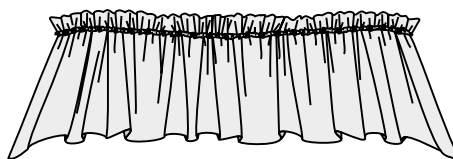

~ Shoulder Valance ~

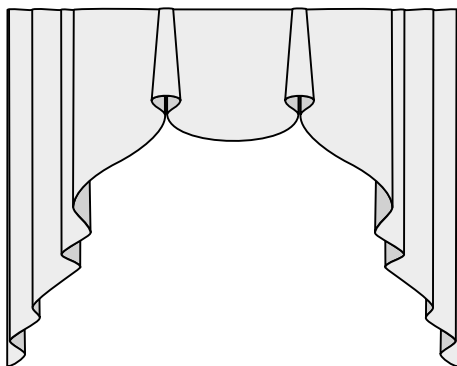

~ Sophia Valance ~

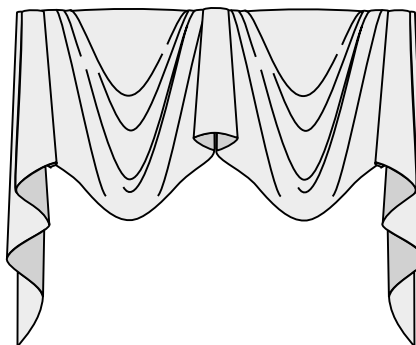

~ Squire Valance ~

Swags and Valances

| Board Mount |

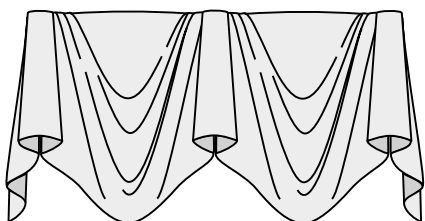

~ Squire Valance ~

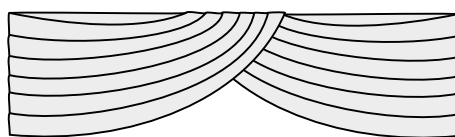

~ Turban Swag ~

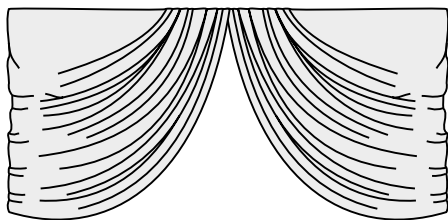

~ Turban Swag ~

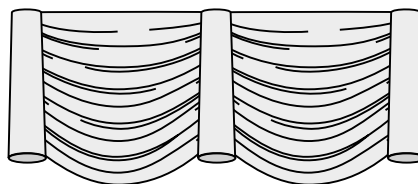

~ Vienna Valance ~

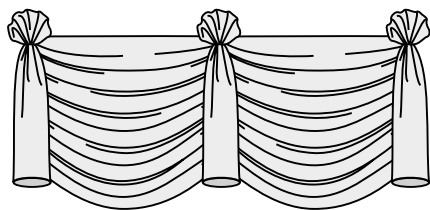

~ Vienna Valance ~

Swags and Valances

| Flags |

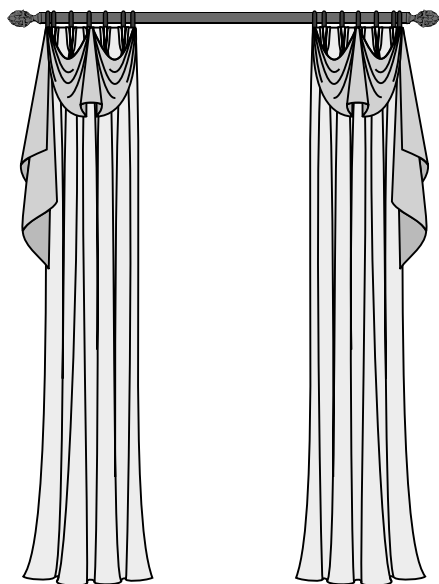

~ Drapery Swag ~

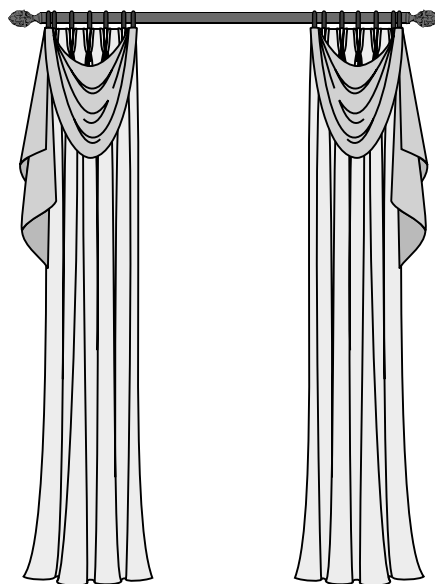

~ Drapery Swag ~

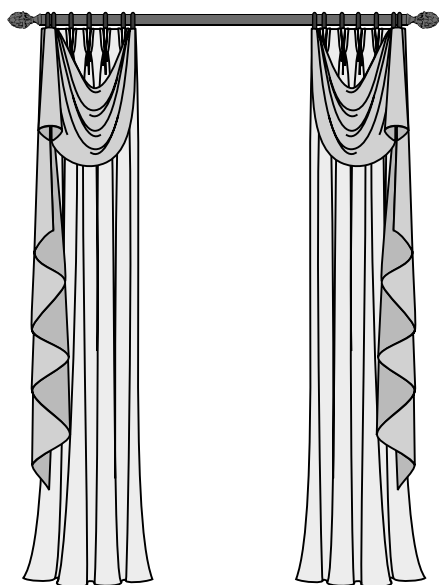

~ Drapery Swag ~

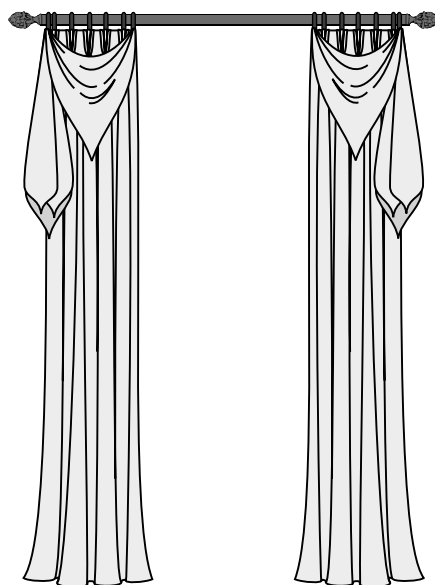

~ Drapery Swag ~

Swags and Valances

| Flags |

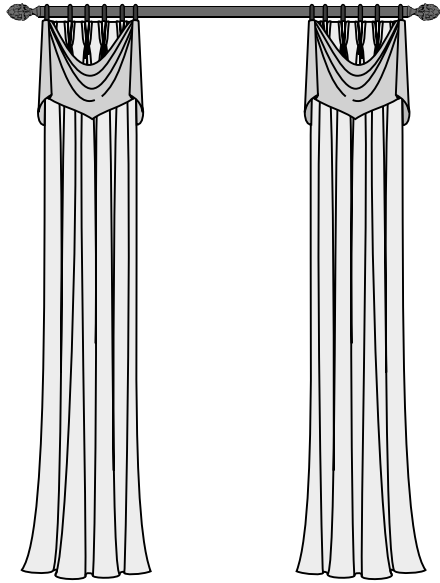

~ Drapery Swag ~

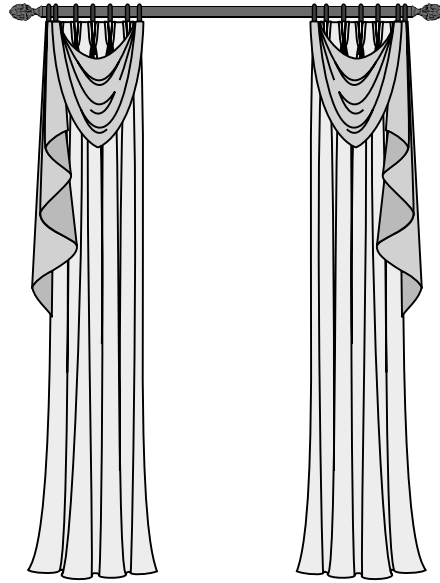

~ Drapery Swag ~

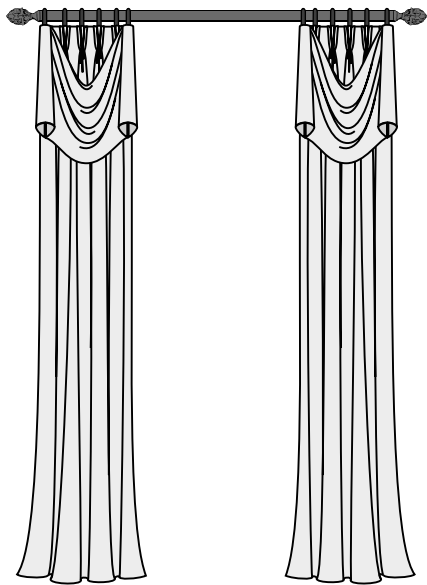

~ Drapery Swag ~

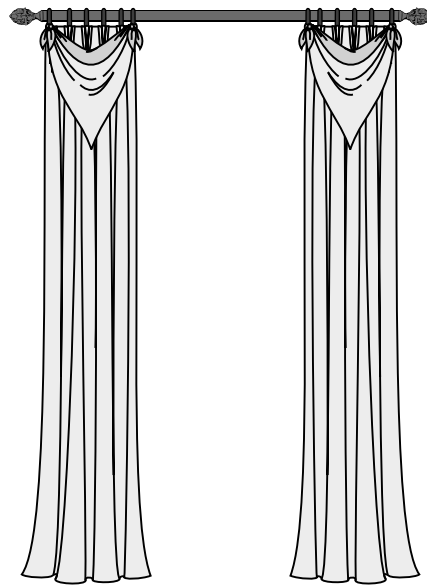

~ Drapery Swag ~

Swags and Valances

| Flags |

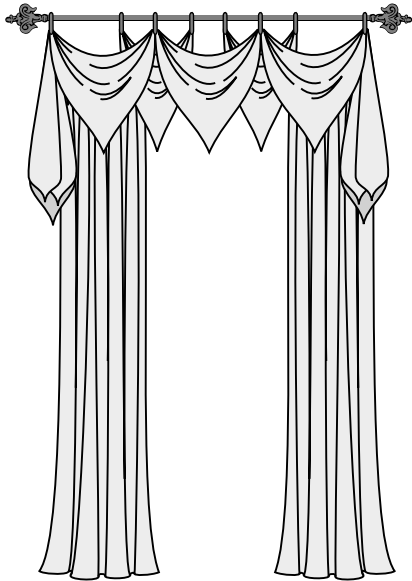

~ Drapery Swag ~

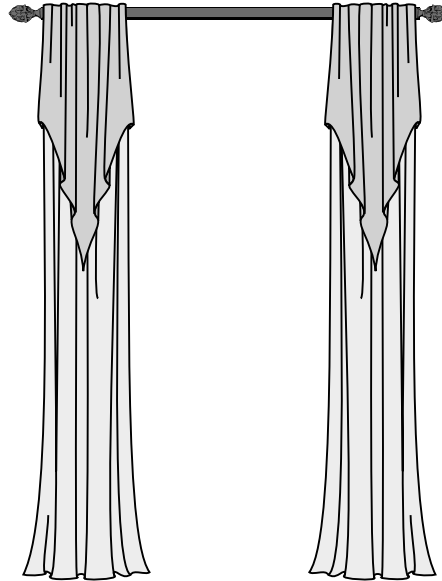

~ Drapery w/Flip Pointed Valance ~

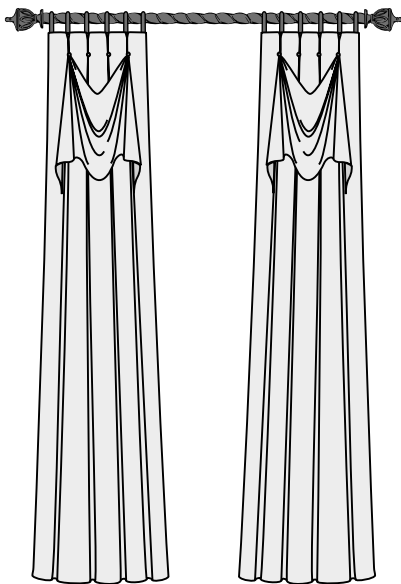

~ Elegant Swag ~

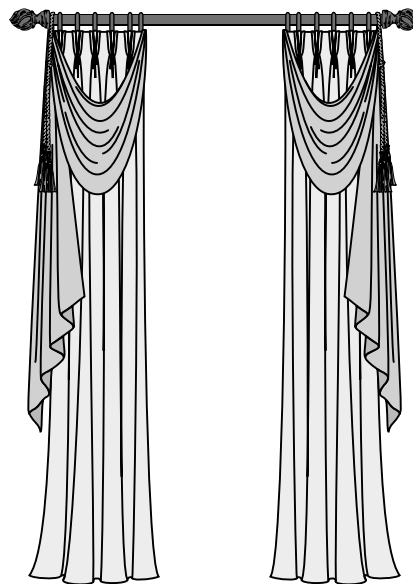

~ One Piece Swag and Cascade ~

Swags and Valances

| Hanger |

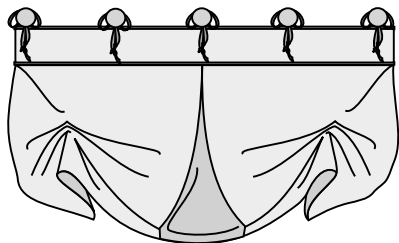

~ Abigail Valance ~

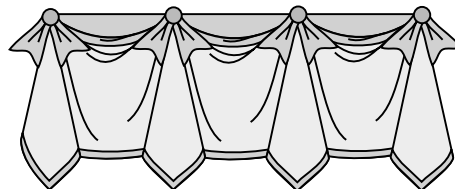

~ Anna Valance ~

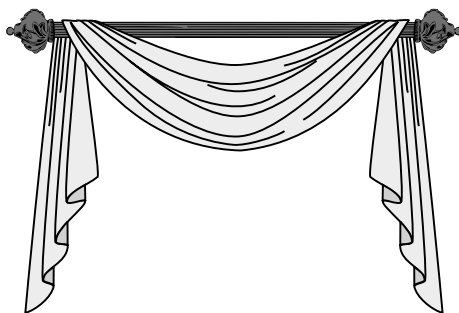

~ Basic Pole Swag ~

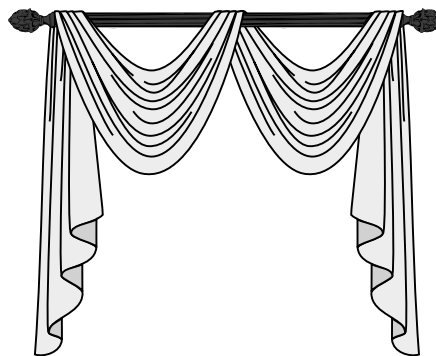

~ Basic Pole Swag ~

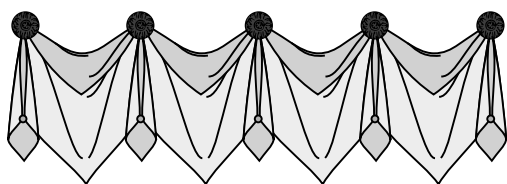

~ Bistro Swags and Valances ~

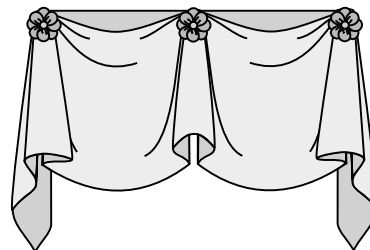

~ Brenthaven Valance ~

Swags and Valances

| Hanger |

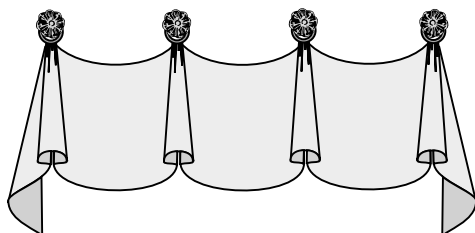

~ Carolina Valance ~

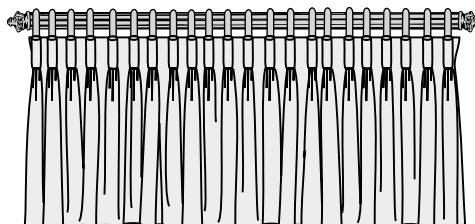

~ Cartridge Valance ~

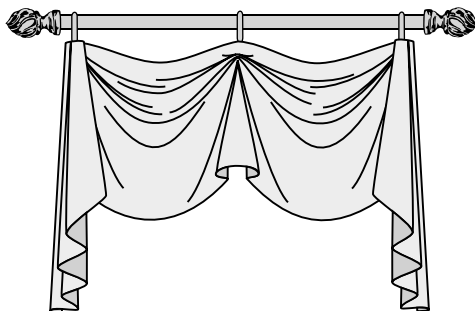

~ Catherine Valance ~

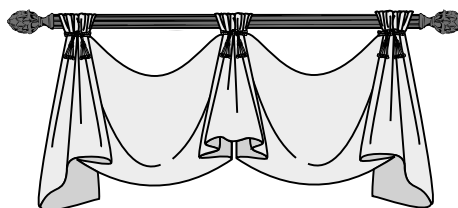

~ Celebration Valance ~

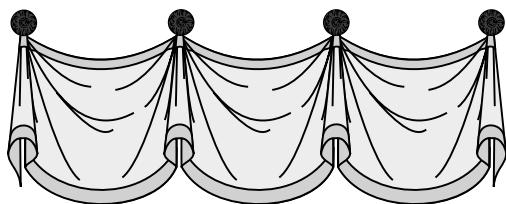

~ Claudine Valance ~

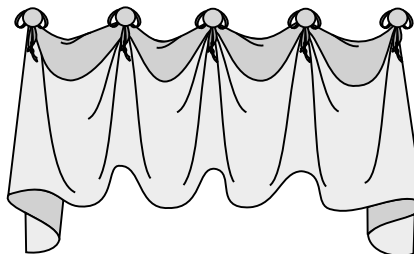

~ Cuff-Top Valance ~

Swags and Valances

| Hanger |

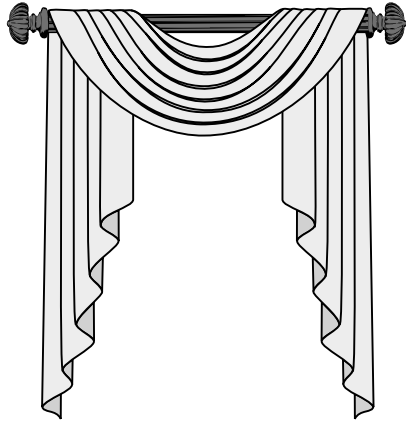

~ Designer Pole Swag ~

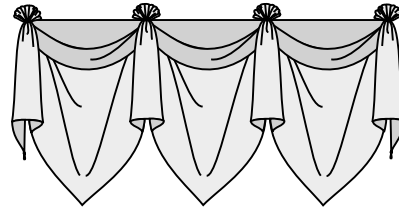

~ Emily Valance ~

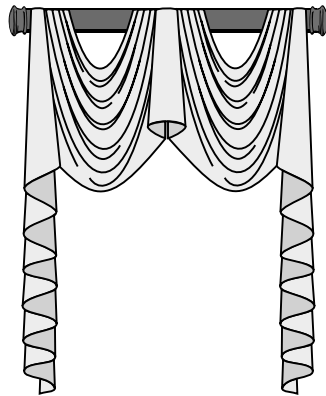

~ Empire Pole Swag ~

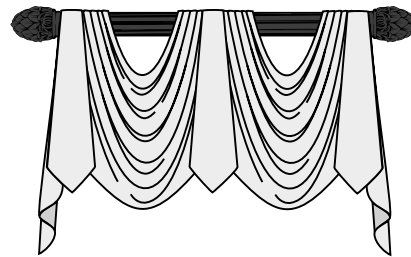

~ Empire Pole Swag ~

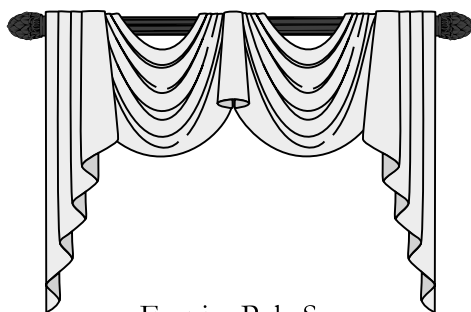

~ Empire Pole Swag ~

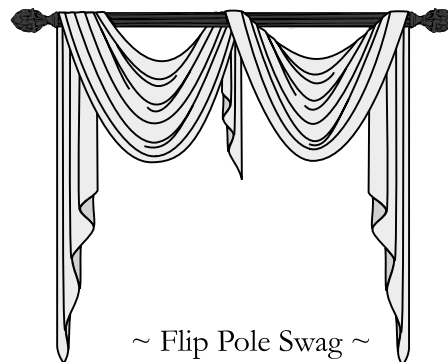

~ Flip Pole Swag ~

Swags and Valances

| Hanger |

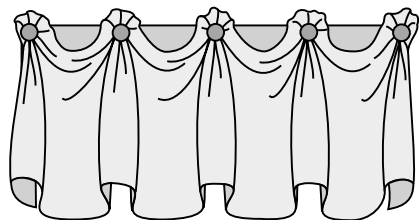

~ Kasey Valance ~

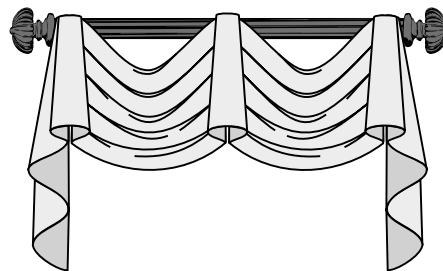

~ Kingston on a Pole ~

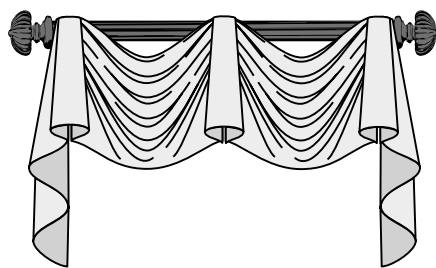

~ Kingston on a Pole ~

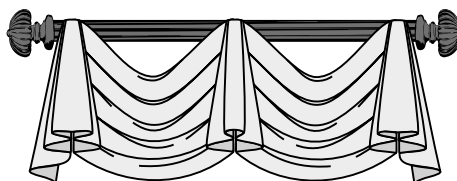

~ Kingston on a Pole ~

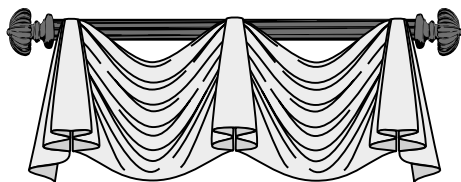

~ Kingston on a Pole ~

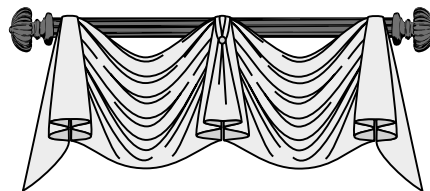

~ Kingston on a Pole ~

Swags and Valances

| Hanger |

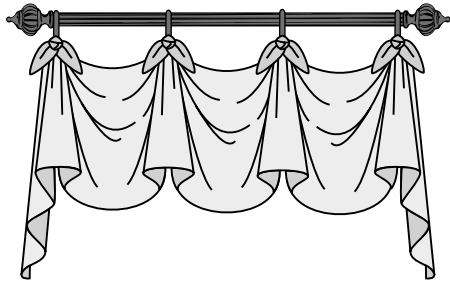

~ Marley Valance ~

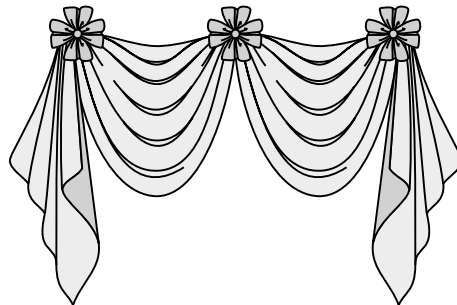

~ Medallion Swag ~

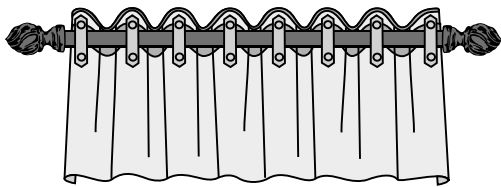

~ Melissa Valance ~

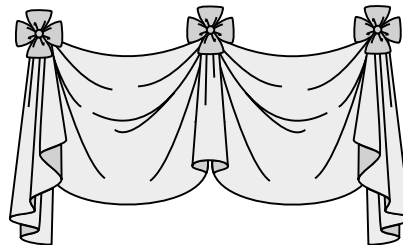

~ Morrison Valance ~

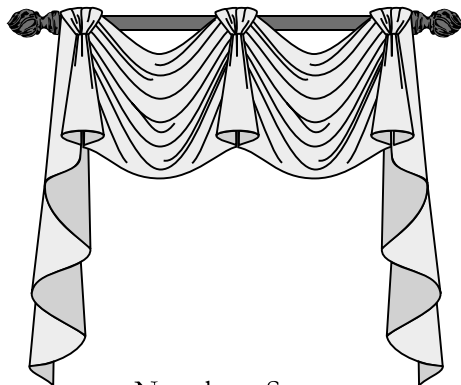

~ Napoleon Swag ~

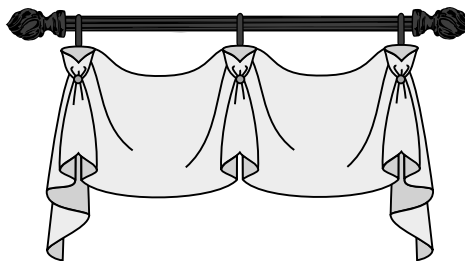

~ Nightingale Valance ~

Swags and Valances

| Hanger |

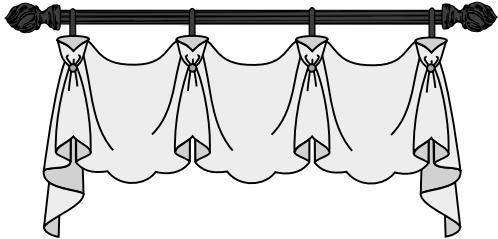

~ Nightingale Valance ~

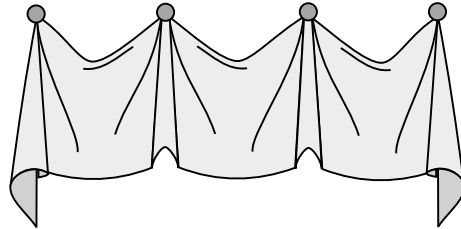

~ Pashmina Valance ~

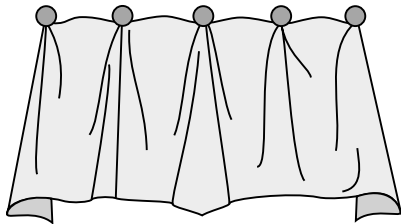

~ Pashmina Valance ~

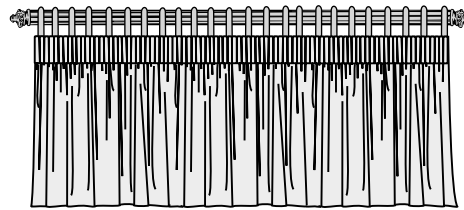

~ Pencil Pleat Valance ~

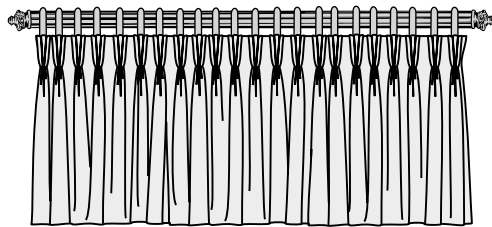

~ Pinch Pleat Valance ~

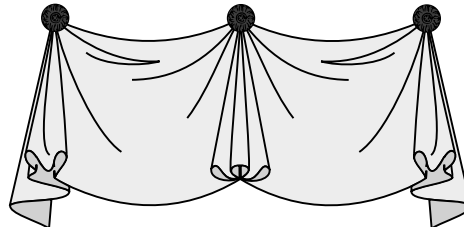

~ Pleated Valance ~

Swags and Valances

| Hanger |

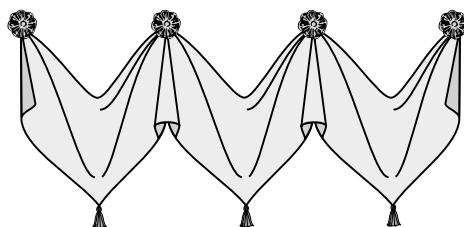

~ Pointed Valance w/Tassels ~

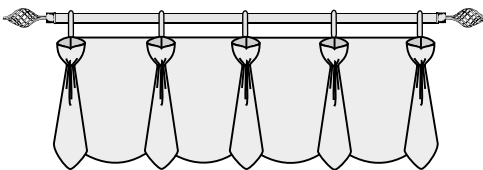

~ Queen Ann Valance ~

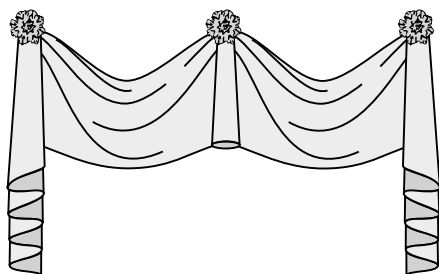

~ Soft Swag w/Cascades ~

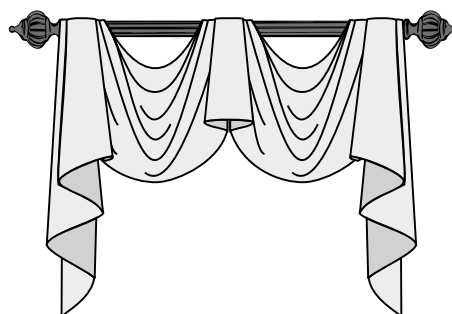

~ Squire Pole Swag ~

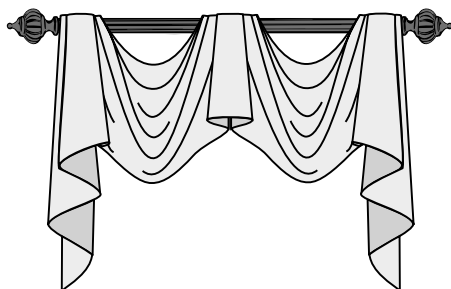

~ Squire Pole Swag ~

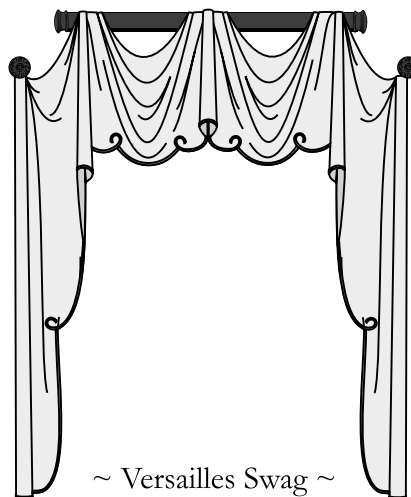

~ Versailles Swag ~

Swags and Valances

| Hanger |

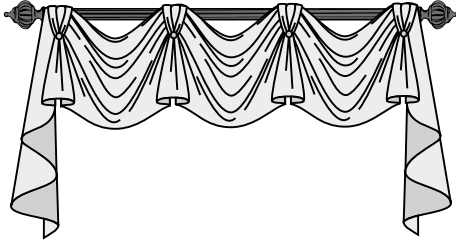

~ Victory Swag ~

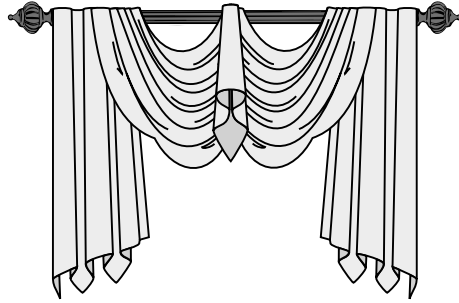

~ Wilshire Swag ~

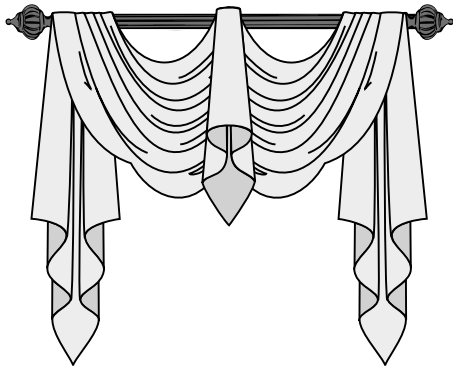

~ Wilshire Swag ~

Swags and Valances

| Pelmet |

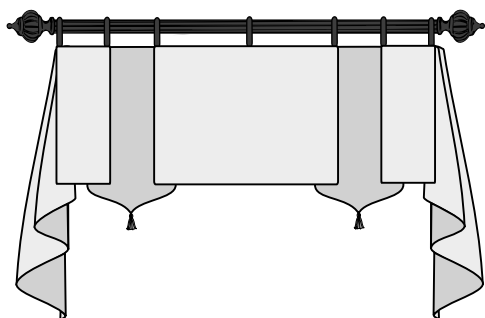

~ Baroque Valance ~

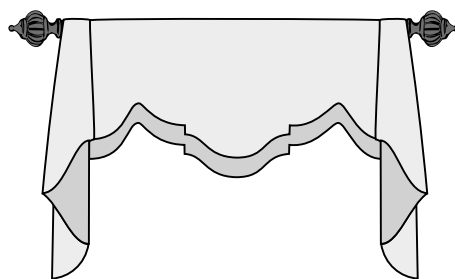

~ Brooklyn Valance ~

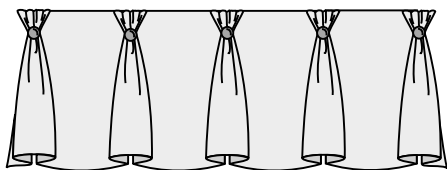

~ Buttons and Bells Valance ~

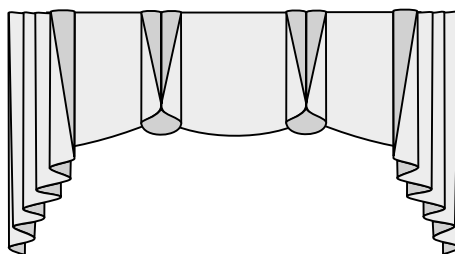

~ Cascade Valance ~



~ Inverted Box Pleat Valance ~

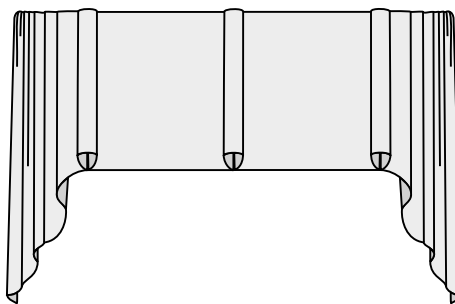

~ Inverted Box Pleat Valance ~

Swags and Valances

| Pelmet |

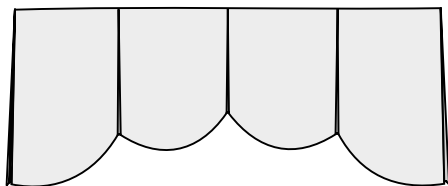

~ Curved Box Valance ~

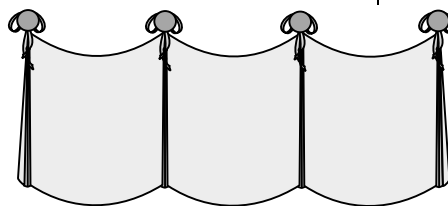

~ Delaine Valance ~

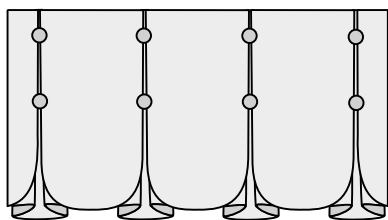

~ Eleanor Valance ~

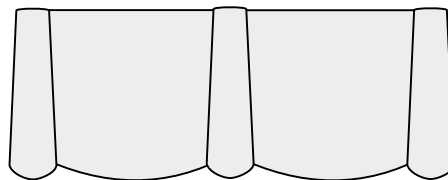

~ Imperial Valance ~

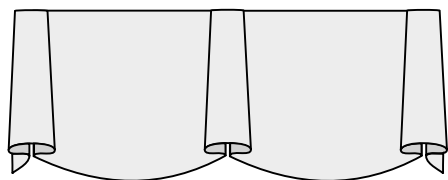

~ Imperial Valance ~

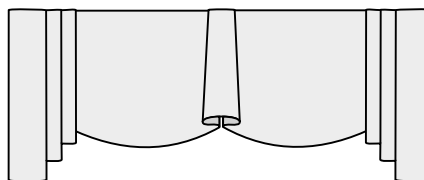

~ Imperial Valance ~

Swags and Valances

| Pelmet |

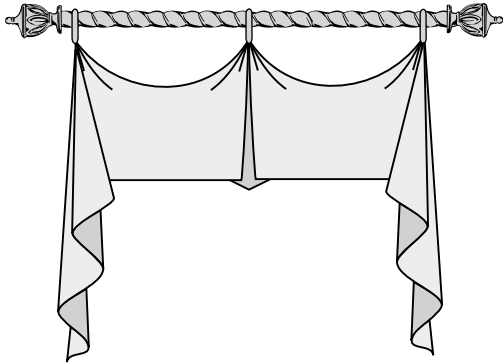

~ Jackson Valance ~

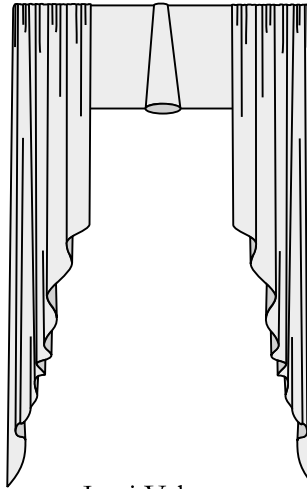

~ Jessi Valance ~

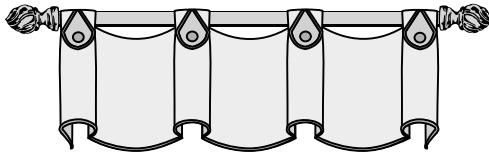

~ Julia Valance ~

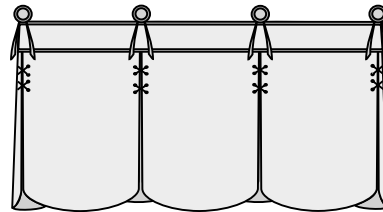

~ Lace-Up Valance ~

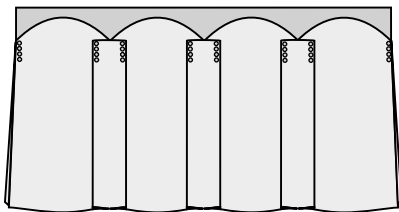

~ Liberty Header ~

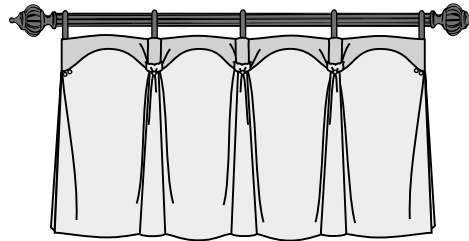

~ Liberty Header ~

Swags and Valances

| Pelmet |

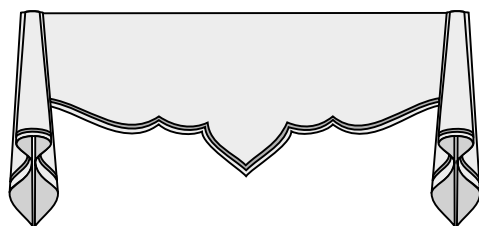

~ Louis XV Valance ~

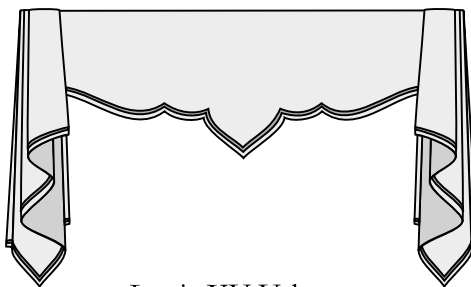

~ Louis XV Valance ~

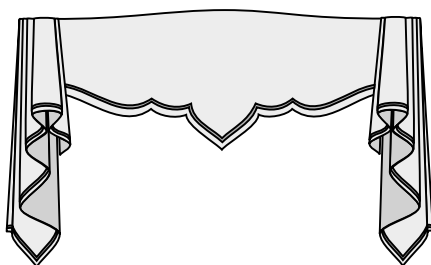

~ Louis XV Valance ~

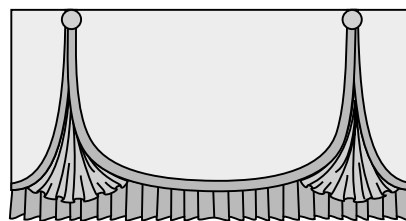

~ Madelyn Valance ~



~ Melody Valance ~

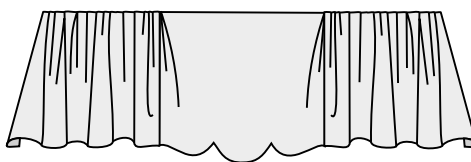

~ Melody Valance ~

Swags and Valances

| Pelmet |

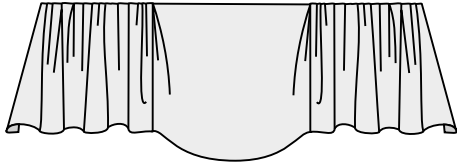

~ Melody Valance ~

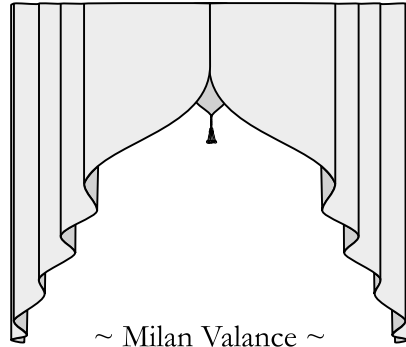

~ Milan Valance ~

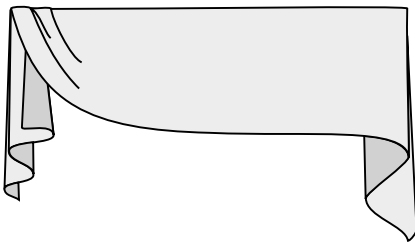

~ Moreland Valance ~

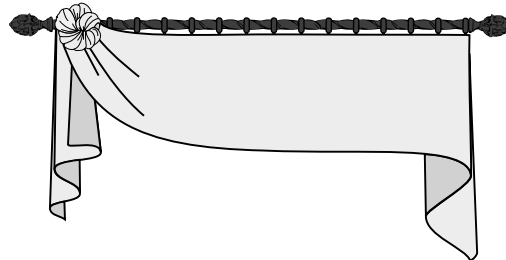

~ Moreland Valance ~

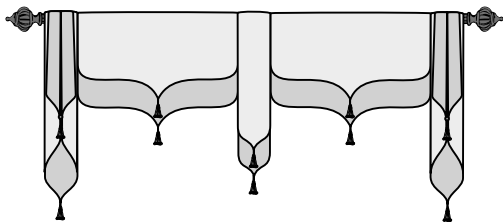

~ Moroccan Valance ~

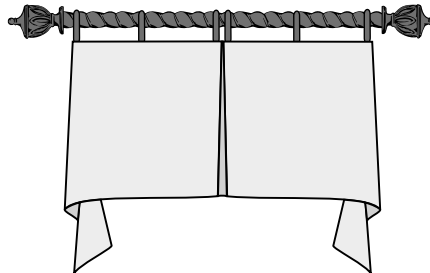

~ Pashmina Valance ~

Swags and Valances

| Pelmet |

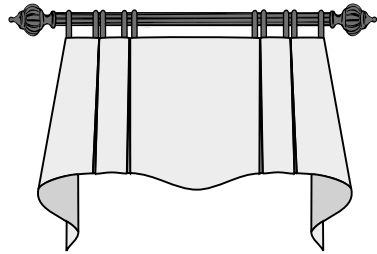

~ Pashmina Valance ~

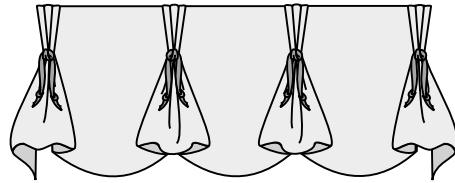

~ Queen Ann Valance ~

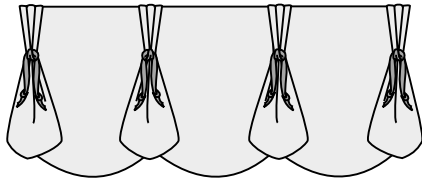

~ Queen Ann Valance ~

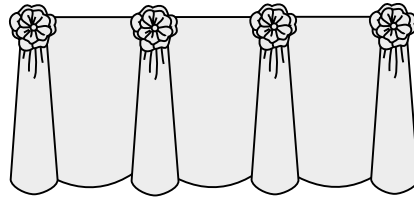

~ Queen Ann Valance ~

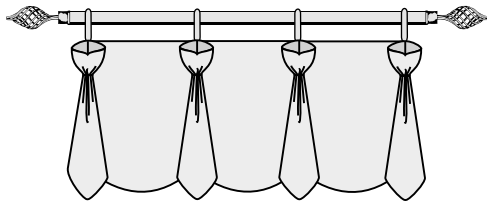

~ Queen Ann Valance ~

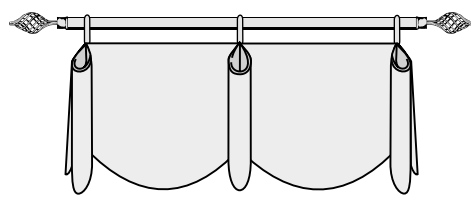

~ Queen Ann Valance ~

Swags and Valances

| Pelmet |

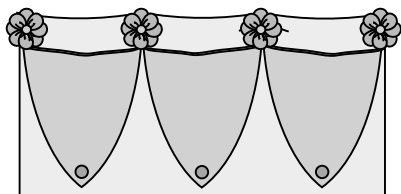

~ Rosette Valance ~

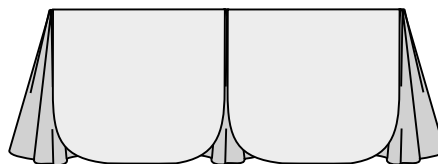

~ Shaped Pelmet ~

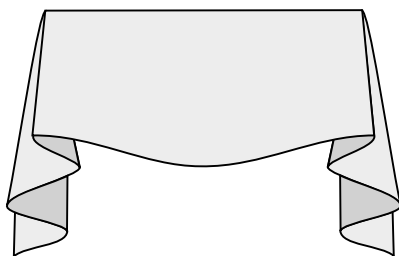

~ Shawl Valance ~

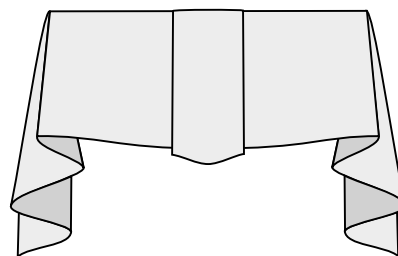

~ Shawl Valance ~

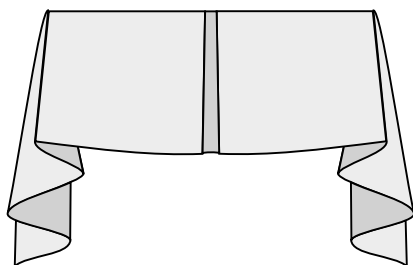

~ Shawl Valance ~

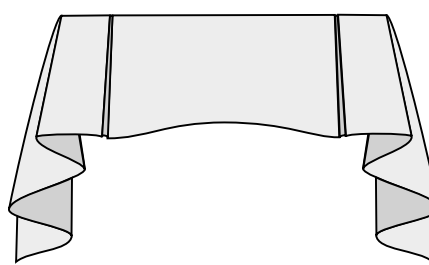

~ Shawl Valance ~

Swags and Valances

| Pelmet |

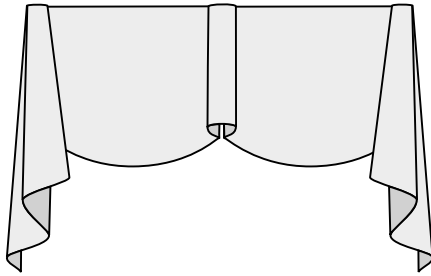

~ Sheffield Valance ~

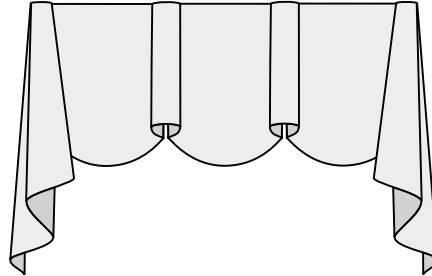

~ Sheffield Valance ~

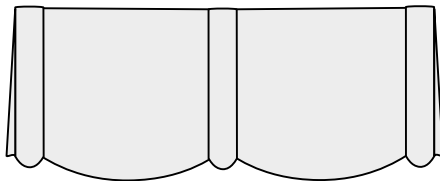

~ Sheffield Valance ~

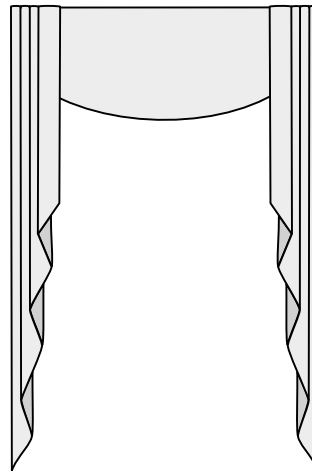

~ Tailored Swag and Cascade ~

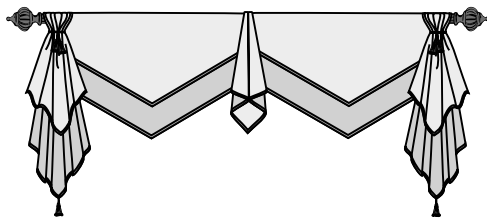

~ Tucker Valance ~

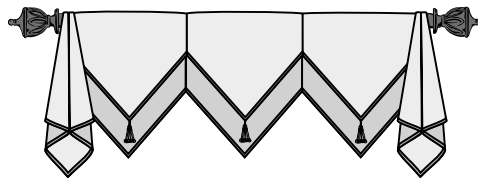

Tucker Valance ~

Swags and Valances

| Rod Pocket |

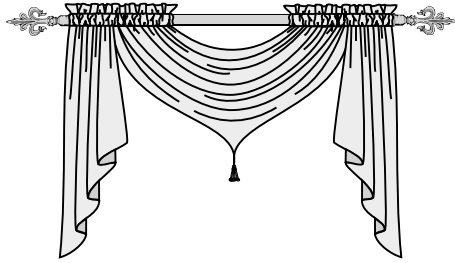

~ Easy Pole Swag ~

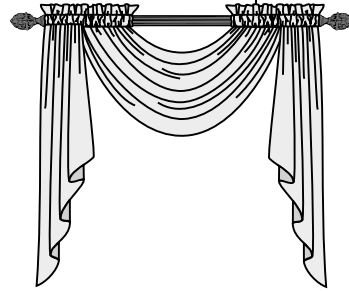

~ Easy Pole Swag ~

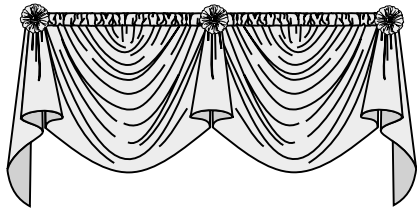

~ Empire on a Rod ~

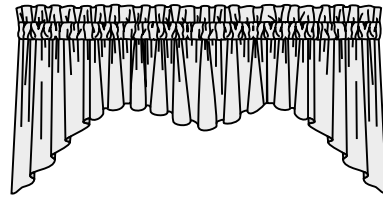

~ Mix and Match Valances ~

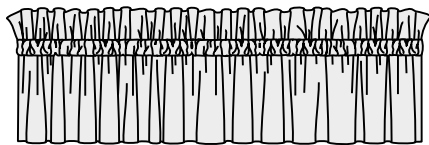

~ Mix and Match Valance ~

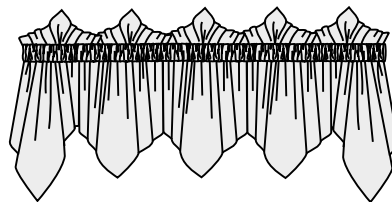

~ Mix and Match Valance ~

Swags and Valances

| Rod Pocket |

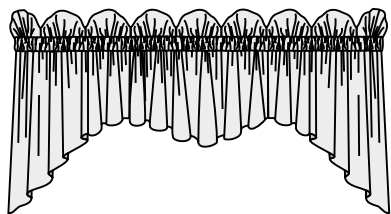

~ Mix and Match Valance ~

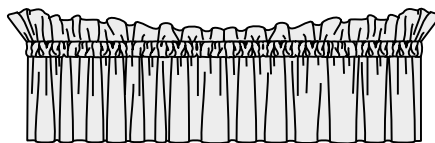

~ Mix and Match Valance ~

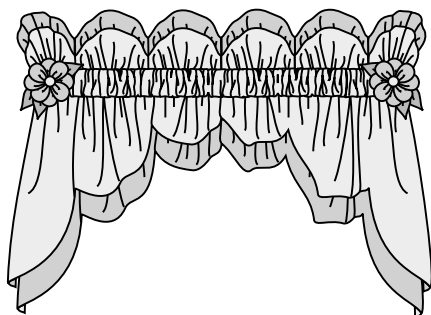

~ Petal Valance ~

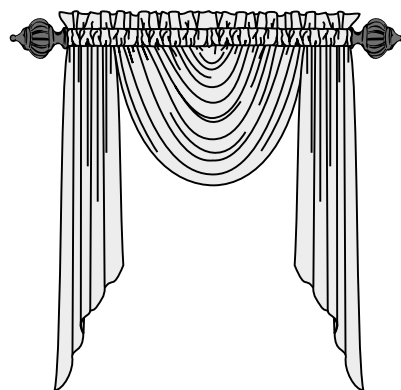

~ Rod Pocket Swag ~

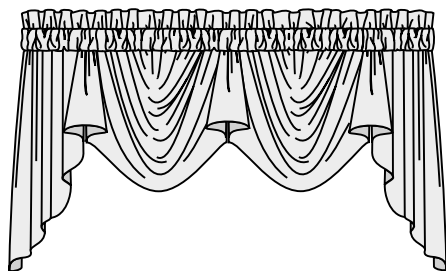

~ Victorian Valance ~

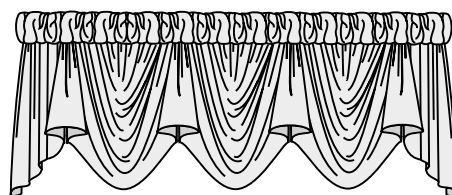

~ Victorian Valance ~

Style:

Living Room
— Furniture



Living Room Furniture

| Benches |

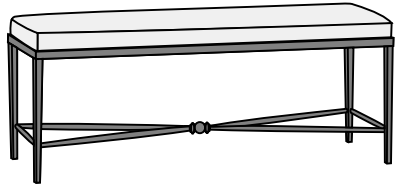

~ Iron Bench ~

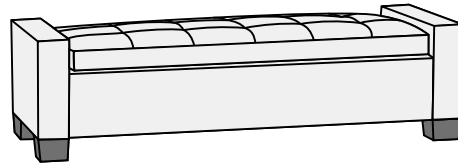

~ Upholstered Bench ~

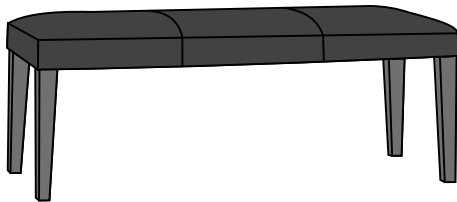

~ Upholstered Bench ~

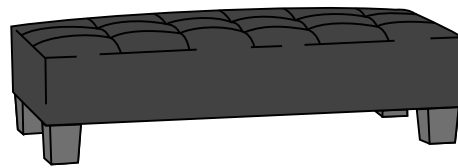

~ Upholstered Bench ~

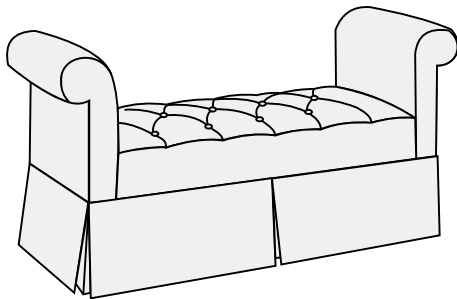

~ Upholstered Bench ~

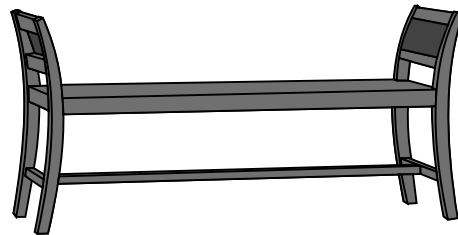

~ Wood Bench ~

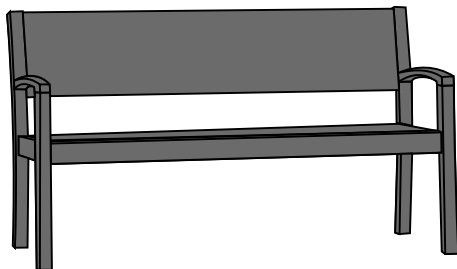

~ Wood Bench ~

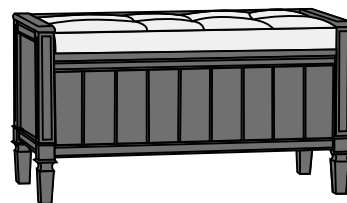

~ Wood Bench ~

Living Room Furniture

| Chairs |



~ Accent Chair ~

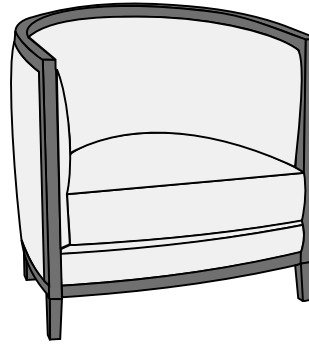

~ Accent Chair ~

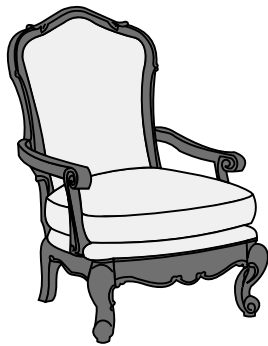

~ Accent Chair ~

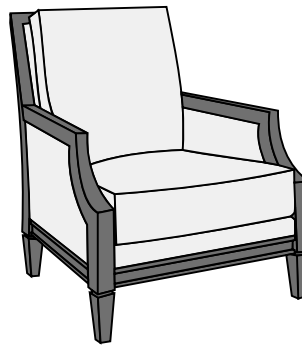

~ Accent Chair ~

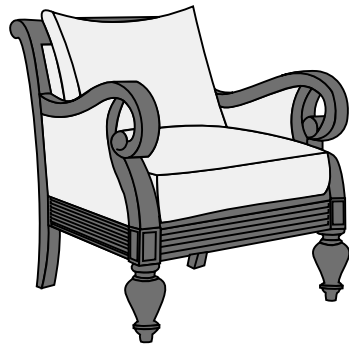

~ Accent Chair ~

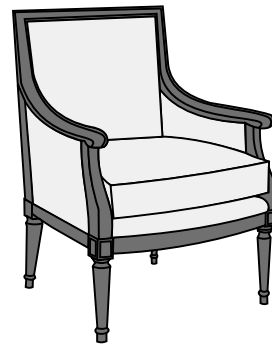

~ Accent Chair ~

Living Room Furniture

| Chairs |

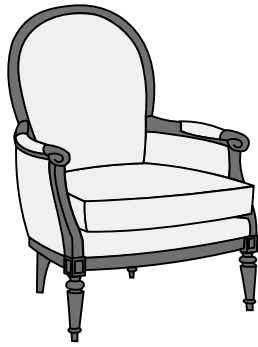

~ Accent Chair ~



~ Accent Chair ~

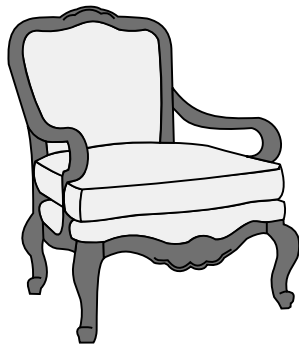

~ Accent Chair ~

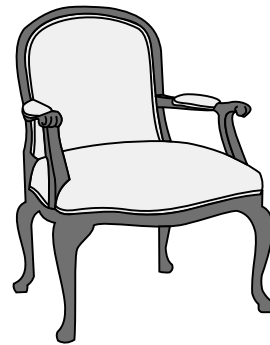

~ Accent Chair ~

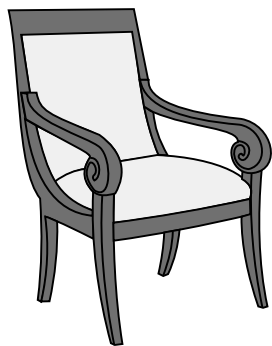

~ Accent Chair ~

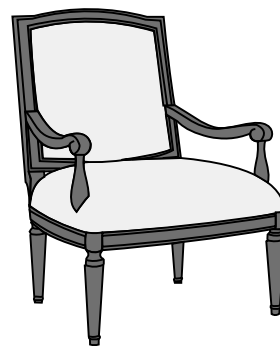

~ Accent Chair ~

Living Room Furniture

| Chairs |

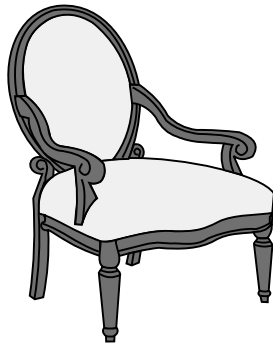

~ Accent Chair ~

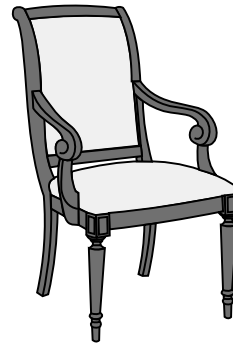

~ Accent Chair ~

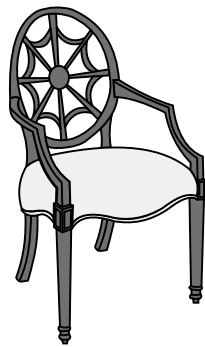

~ Accent Chair ~

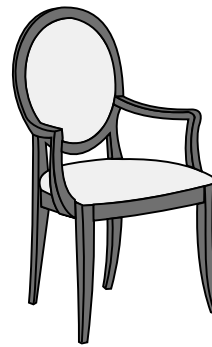

~ Accent Chair ~

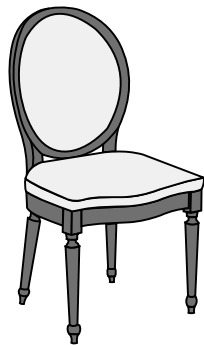

~ Accent Chair ~

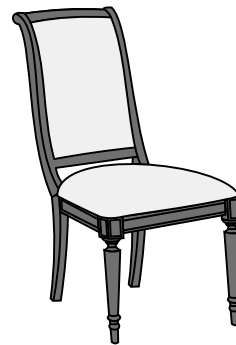

~ Accent Chair ~

Living Room Furniture

| Chairs |

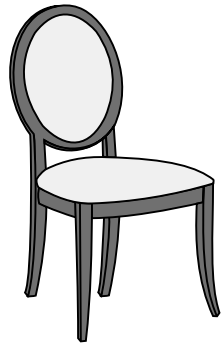

~ Accent Chair ~

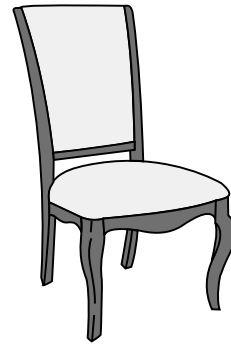

~ Accent Chair ~

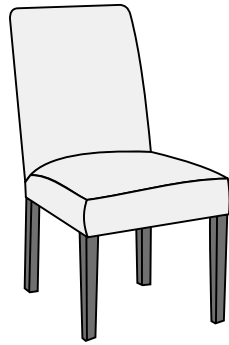

~ Accent Chair ~

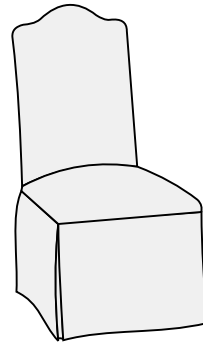

~ Accent Chair ~

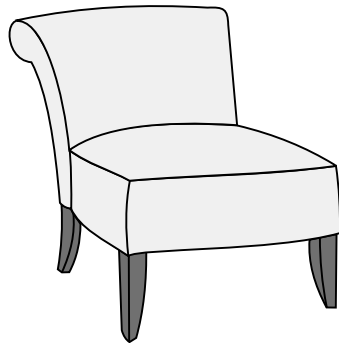

~ Accent Chair ~

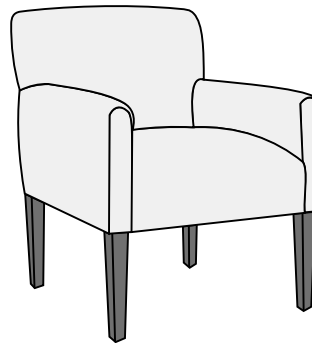

~ Accent Chair ~

Living Room Furniture

| Chairs |

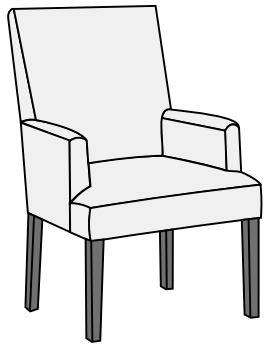

~ Accent Chair ~

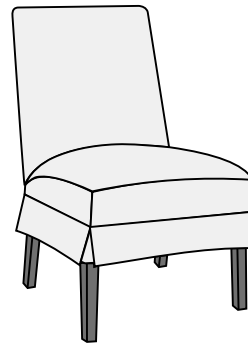

~ Accent Chair ~

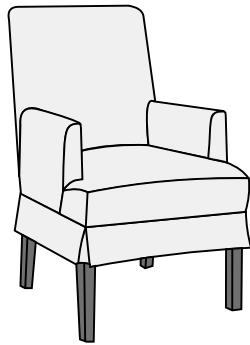

~ Accent Chair ~

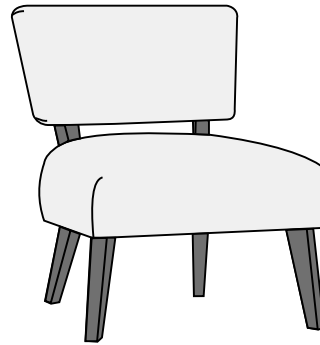

~ Accent Chair ~

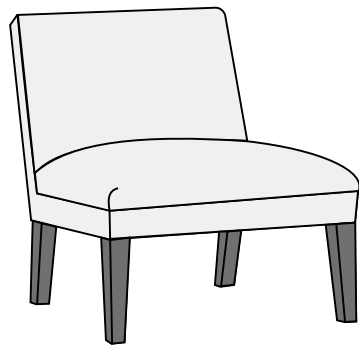

~ Accent Chair ~

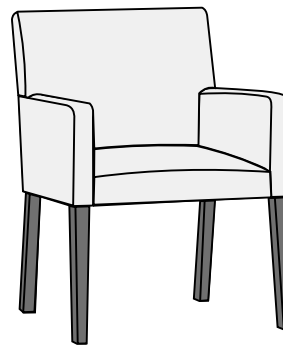

~ Accent Chair ~

Living Room Furniture

| Chairs |



~ Accent Chair ~

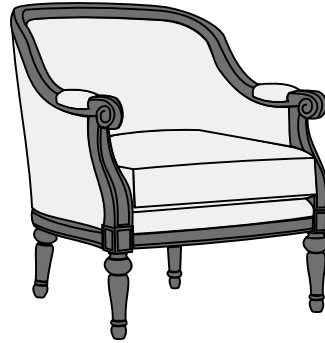

~ Accent Chair ~

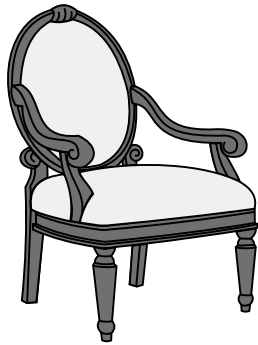

~ Accent Chair ~



~ Accent Chair ~

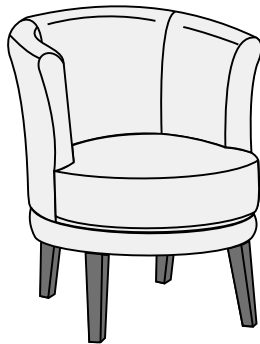

~ Accent Chair ~

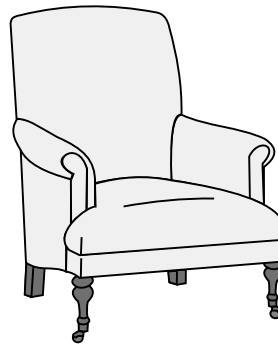

~ Accent Chair ~

Living Room Furniture

| Chairs |

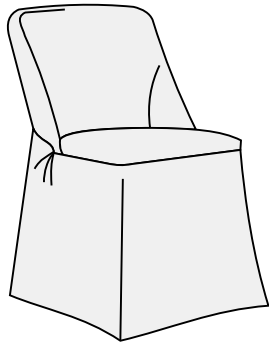

~ Accent Chair ~

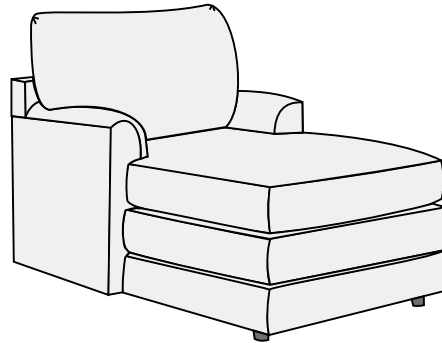

~ Chaise Lounge ~

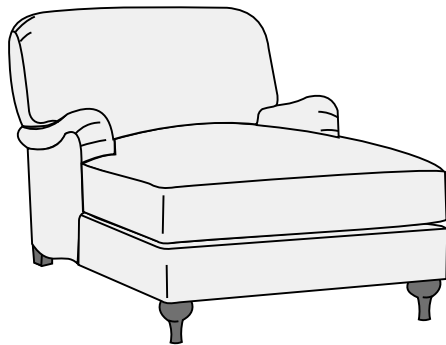

~ Chaise Lounge ~

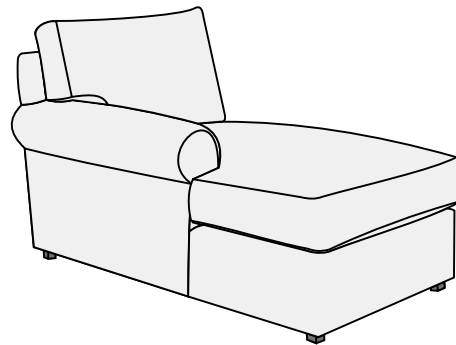

~ Chaise Lounge ~

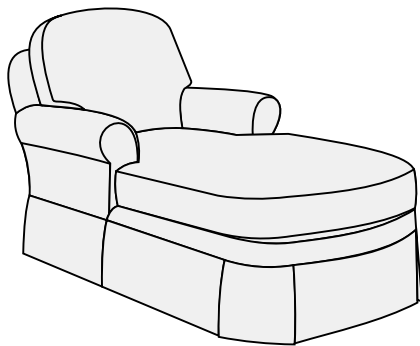

~ Chaise Lounge ~

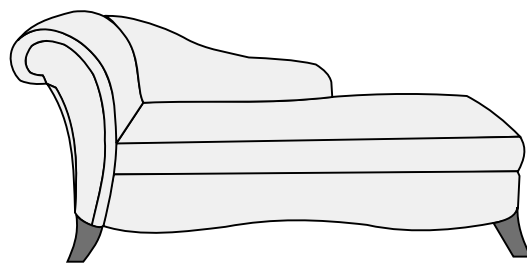

~ Chaise Lounge ~

Living Room Furniture

| Chairs |

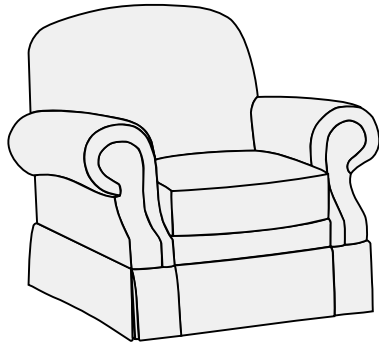

~ Club Chair ~

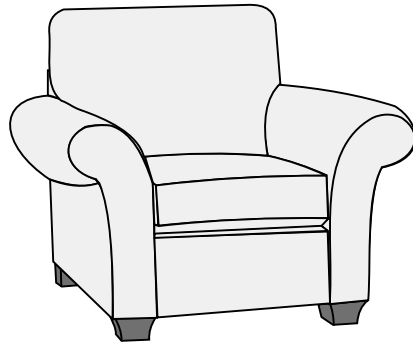

~ Club Chair ~

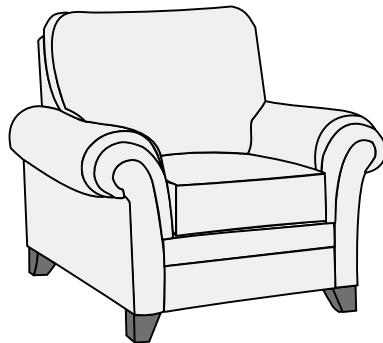

~ Club Chair ~

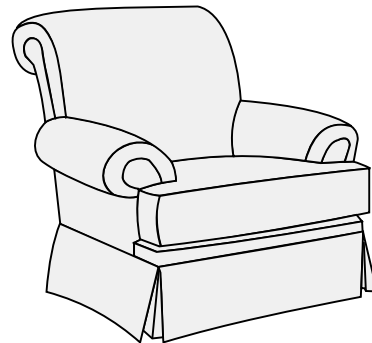

~ Club Chair ~

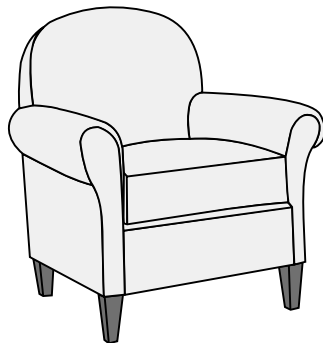

~ Club Chair ~

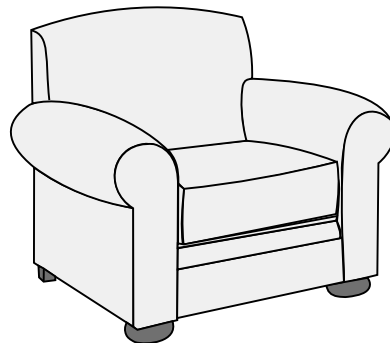

~ Club Chair ~

Living Room Furniture

| Chairs |

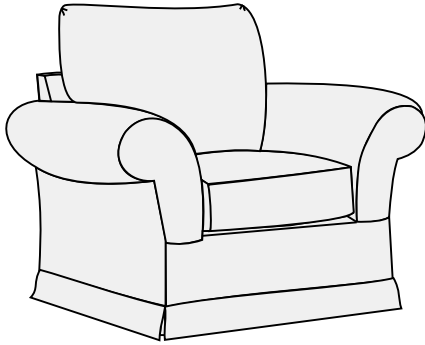

~ Club Chair ~

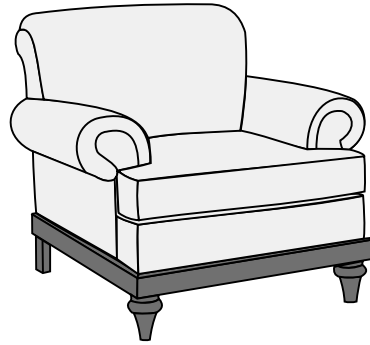

~ Club Chair ~

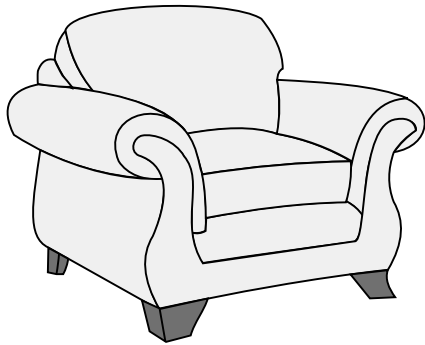

~ Club Chair ~

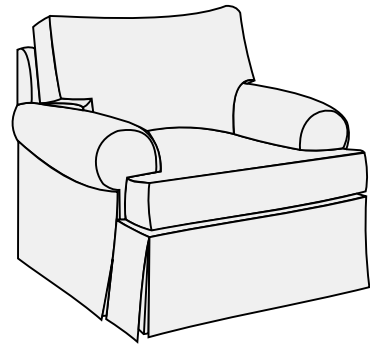

~ Club Chair ~

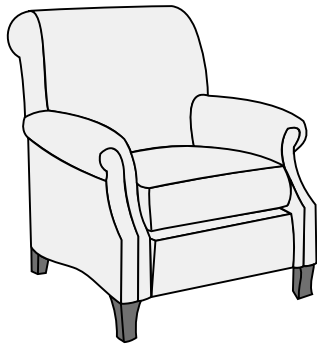

~ Club Chair ~

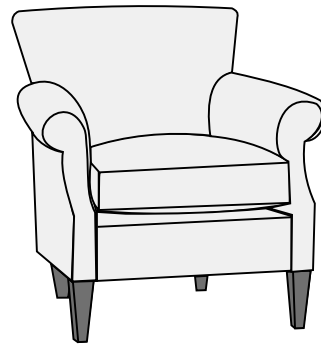

~ Club Chair ~

Living Room Furniture

| Chairs |



~ Office Chair ~



~ Office Chair ~

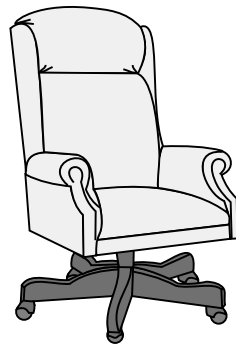

~ Office Chair ~

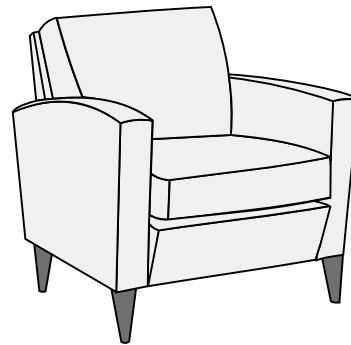

~ Tailored Chair ~

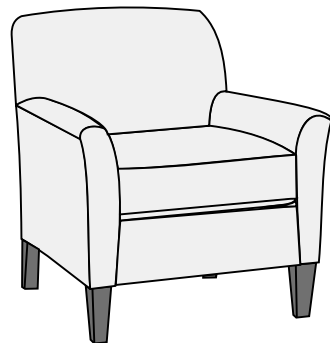

~ Tailored Chair ~

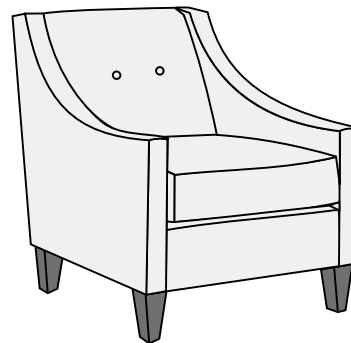

~ Tailored Chair ~

Living Room Furniture

| Chairs |

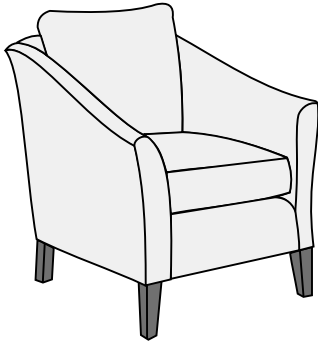

~ Tailored Chair ~

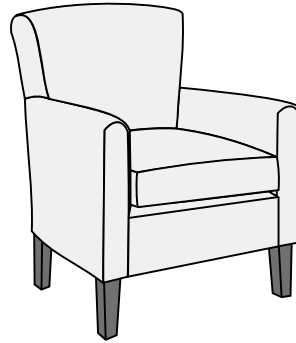

~ Tailored Chair ~

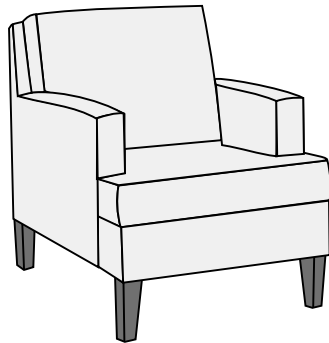

~ Tailored Chair ~

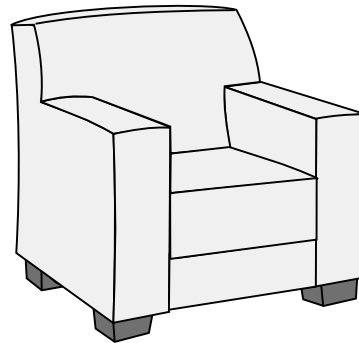

~ Tailored Chair ~

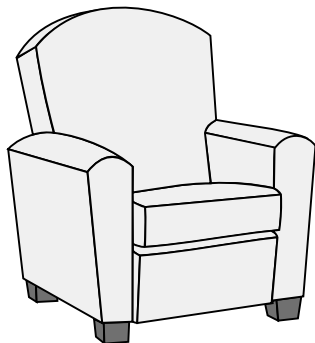

~ Tailored Chair ~

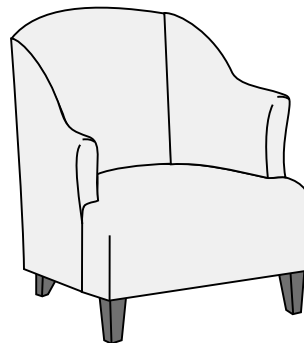

~ Tailored Chair ~

Living Room Furniture

| Chairs |

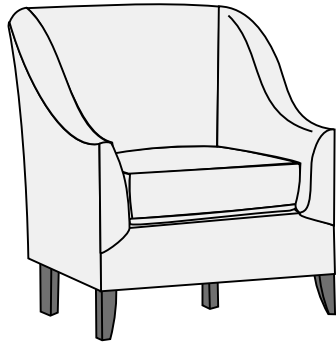

~ Tailored Chair ~

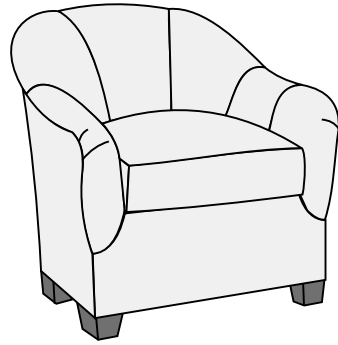

~ Tailored Chair ~

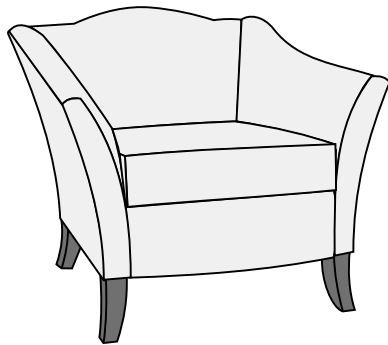

~ Tailored Chair ~

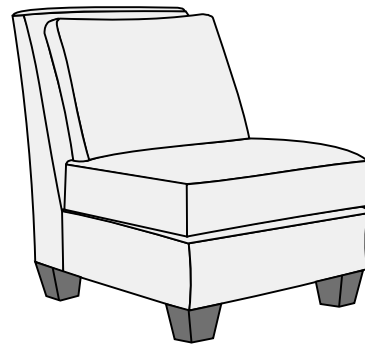

~ Tailored Chair ~

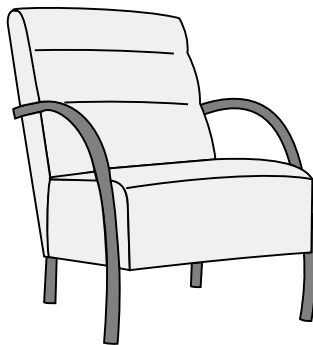

~ Tailored Chair ~

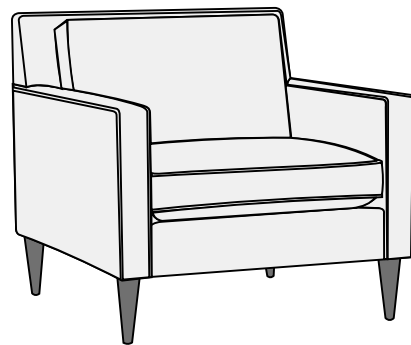

~ Tailored Chair ~

Living Room Furniture

| Chairs |

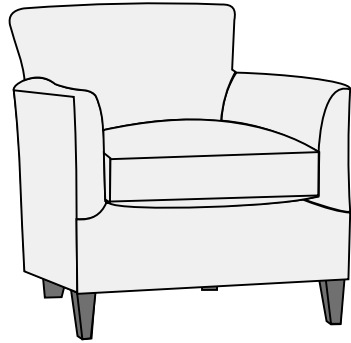

~ Tailored Chair ~

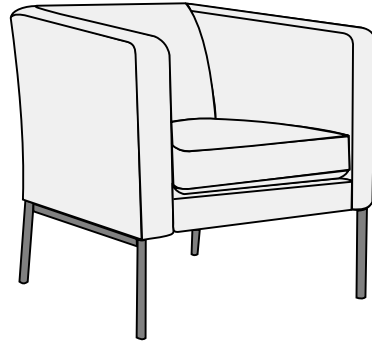

~ Tailored Chair ~

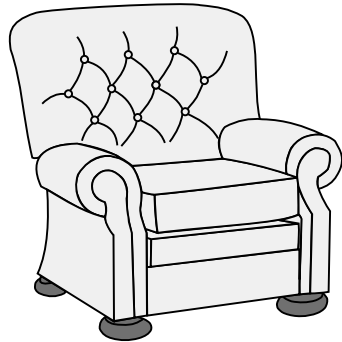

~ Tufted Chair ~

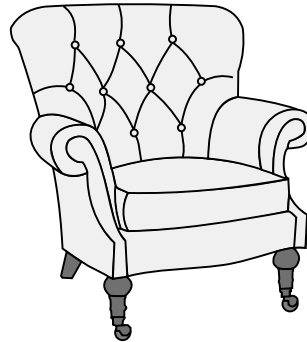

~ Tufted Chair ~

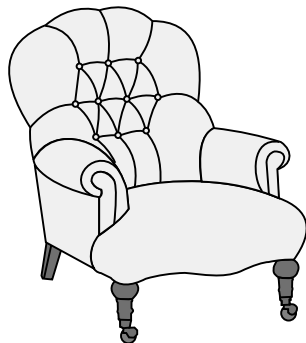

~ Tufted Chair ~

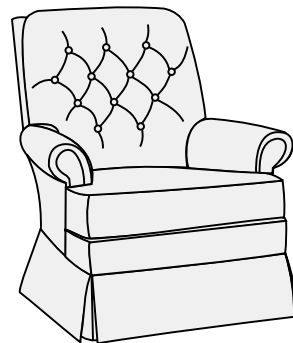

~ Tufted Chair ~

Living Room Furniture

| Chairs |

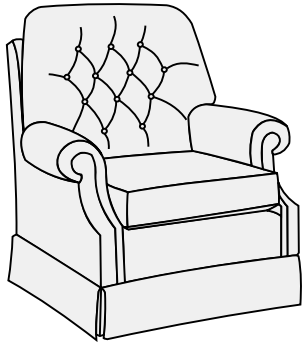

~ Tufted Chair ~

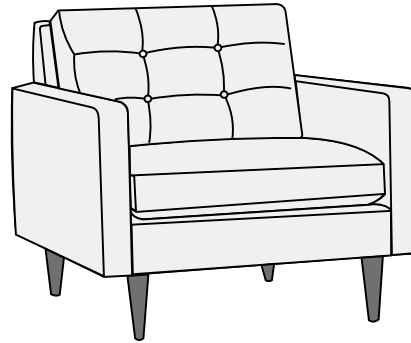

~ Tufted Chair ~

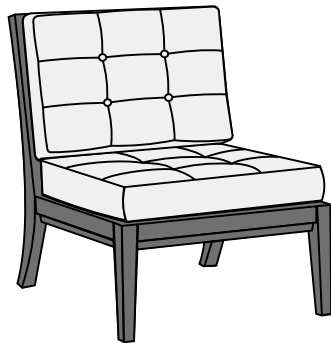

~ Tufted Chair ~

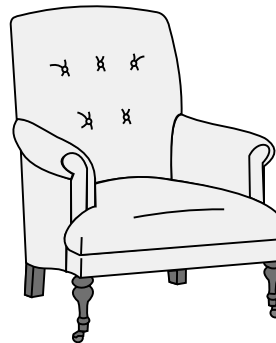

~ Tufted Chair ~

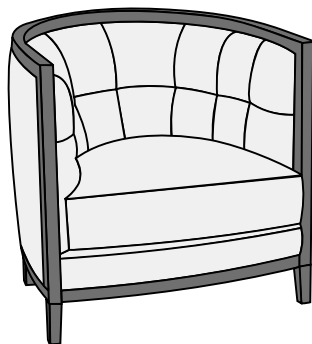

~ Tufted Chair ~

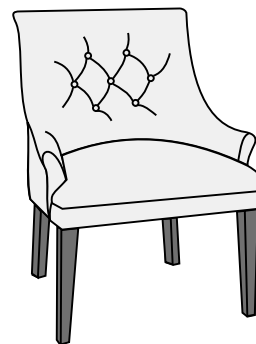

~ Tufted Chair ~

Living Room Furniture

| Chairs |

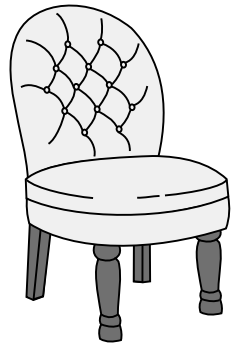

~ Tufted Chair ~

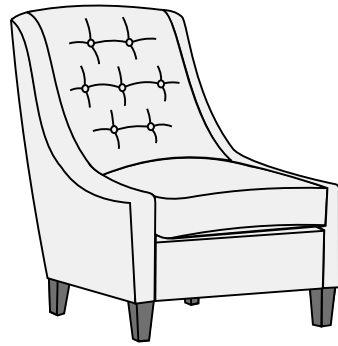

~ Tufted Chair ~

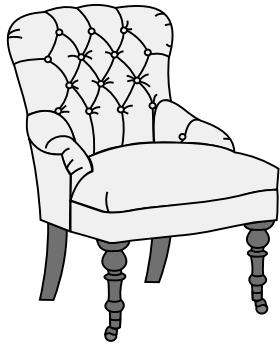

~ Tufted Chair ~

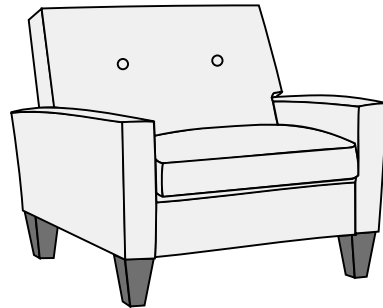

~ Tufted Chair ~

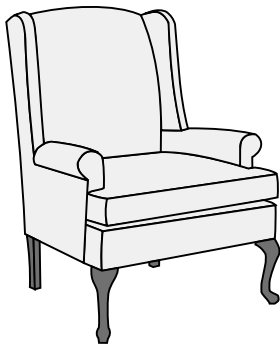

~ Winged Chair ~

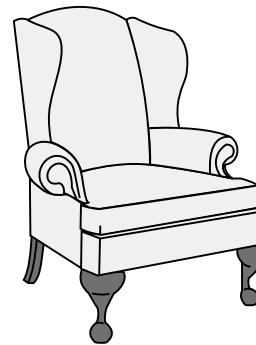

~ Winged Chair ~

Living Room Furniture

| Coffee Tables |

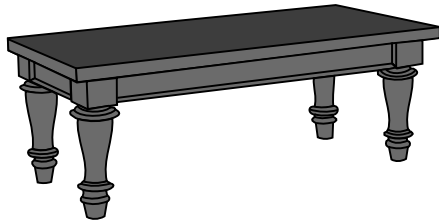

~ Coffee Table ~

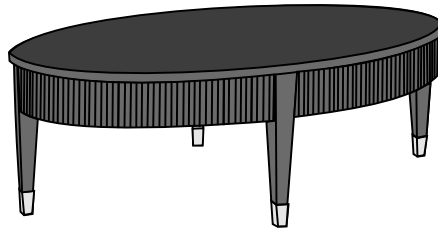

~ Coffee Table ~

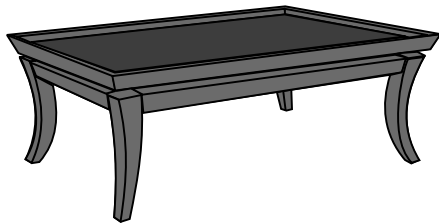

~ Coffee Table ~

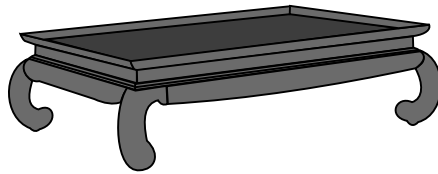

~ Coffee Table ~

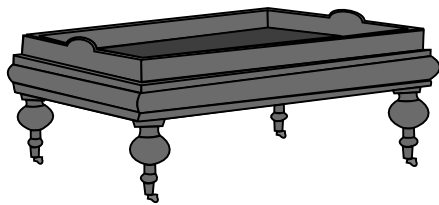

~ Coffee Table ~

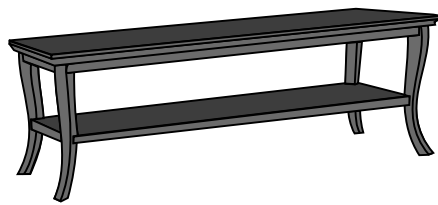

~ Coffee Table ~

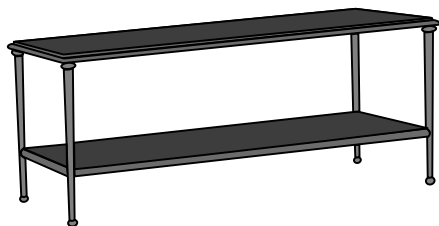

~ Coffee Table ~



~ Coffee Table ~

Living Room Furniture

| Coffee Tables |



~ Coffee Table ~

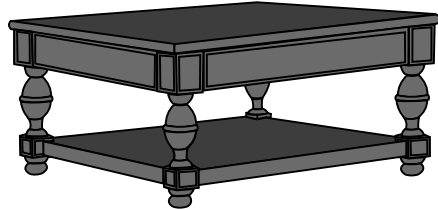

~ Coffee Table ~



~ Coffee Table ~

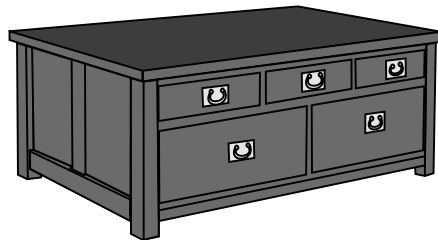

~ Coffee Table ~

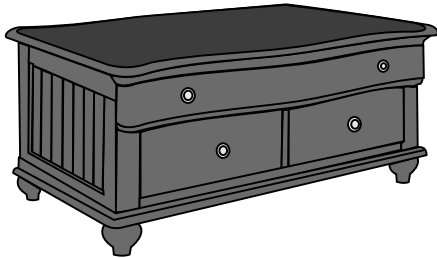

~ Coffee Table ~

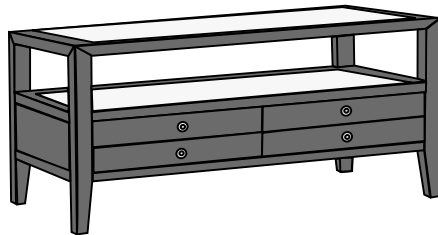

~ Coffee Table ~

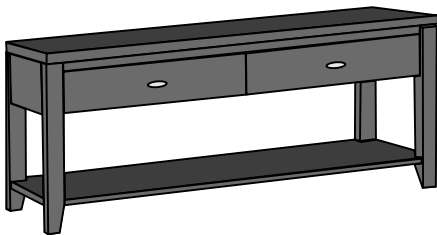

~ Coffee Table ~

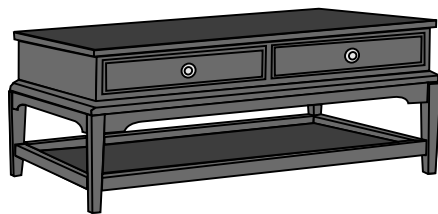

~ Coffee Table ~

Living Room Furniture

| Coffee Tables |

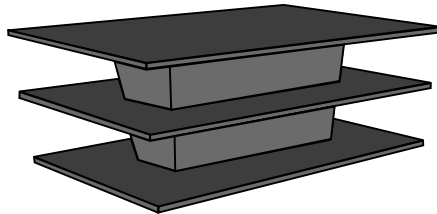

~ Coffee Table ~

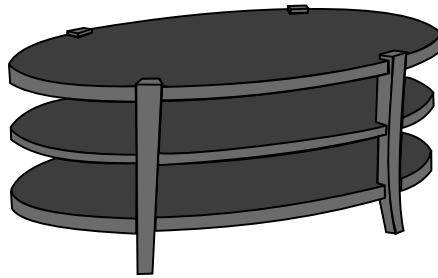

~ Coffee Table ~

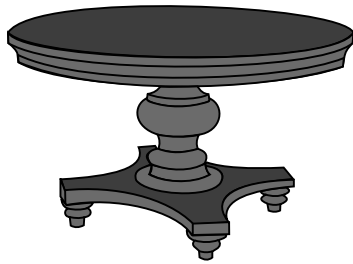

~ Coffee Table ~



~ Coffee Table ~

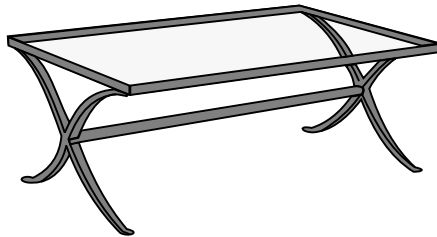

~ Coffee Table ~

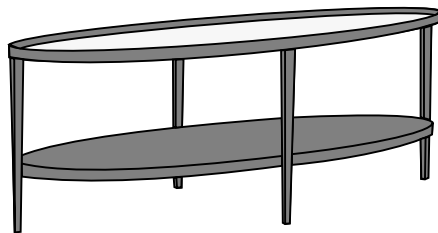

~ Coffee Table ~

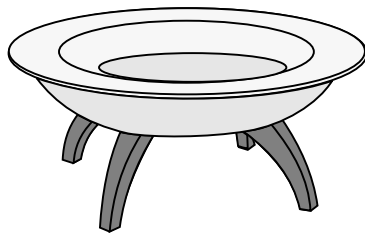

~ Coffee Table ~

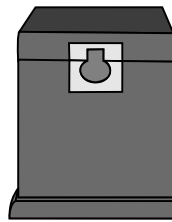

~ Coffee Table ~

Living Room Furniture

| Coffee Tables |



~ Coffee Table ~

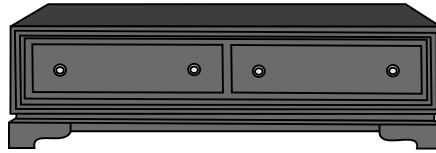

~ Coffee Table ~

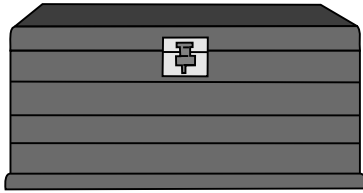

~ Coffee Table ~

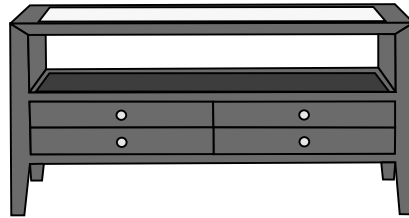

~ Coffee Table ~

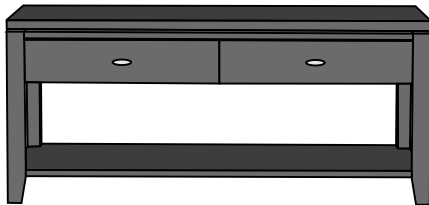

~ Coffee Table ~



~ Coffee Table ~

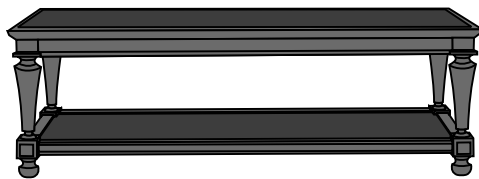

~ Coffee Table ~

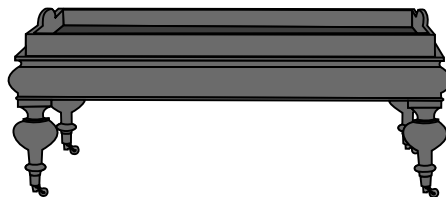

~ Coffee Table ~

Living Room Furniture

| Coffee Tables |

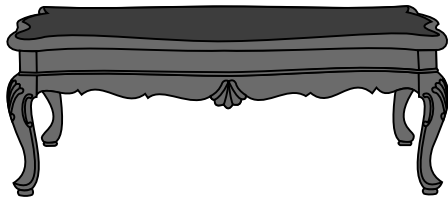

~ Coffee Table ~

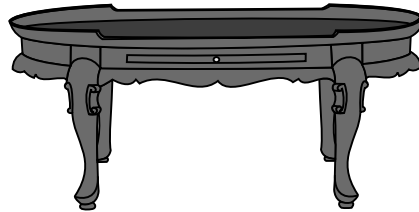

~ Coffee Table ~

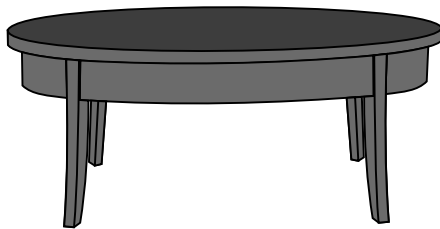

~ Coffee Table ~

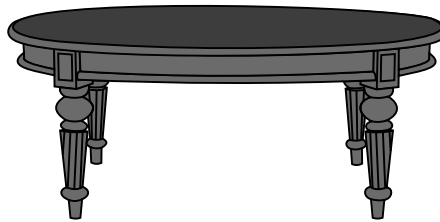

~ Coffee Table ~

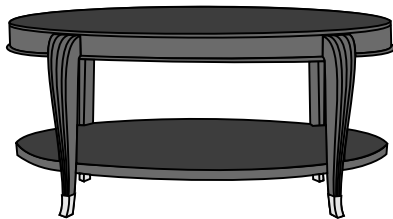

~ Coffee Table ~

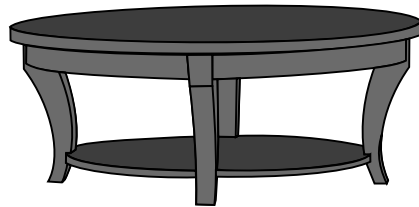

~ Coffee Table ~



~ Coffee Table ~

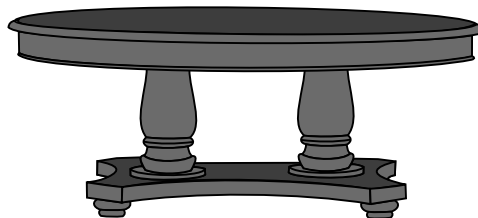

~ Coffee Table ~

Living Room Furniture

| Coffee Tables |

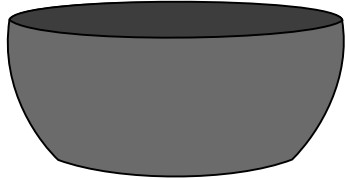

~ Coffee Table ~

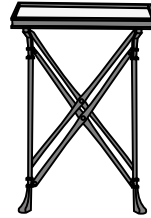

~ Coffee Table ~



~ Coffee Table ~

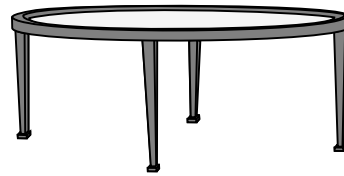

~ Coffee Table ~

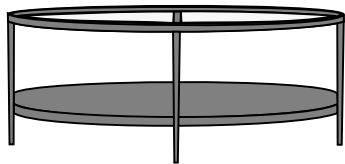

~ Coffee Table ~

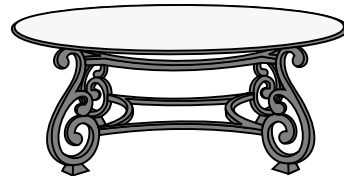

~ Coffee Table ~

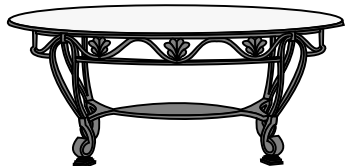

~ Coffee Table ~

Living Room Furniture

| Console Tables |



~ Console Table ~



~ Console Table ~



~ Console Table ~



~ Console Table ~



~ Console Table ~

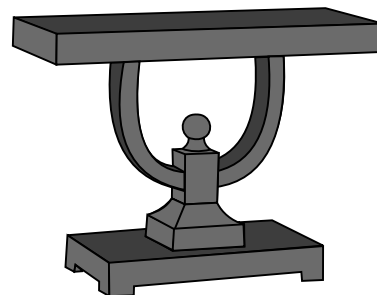

~ Console Table ~

Living Room Furniture

| Console Tables |

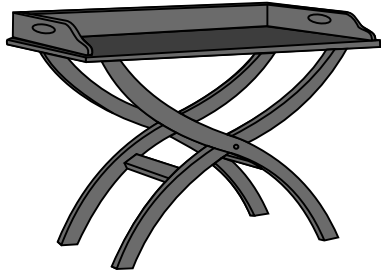

~ Console Table ~



~ Console Table ~

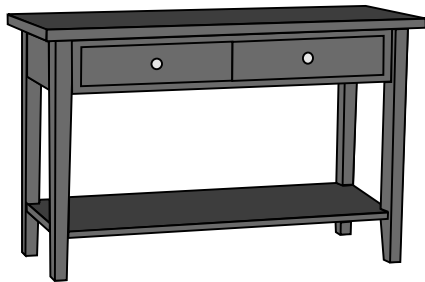

~ Console Table ~

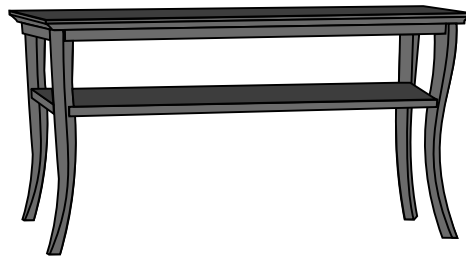

~ Console Table ~

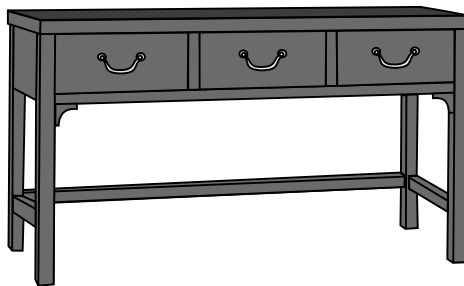

~ Console Table ~

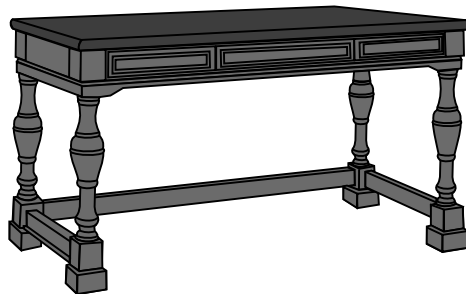

~ Console Table ~

Living Room Furniture

| Console Tables |

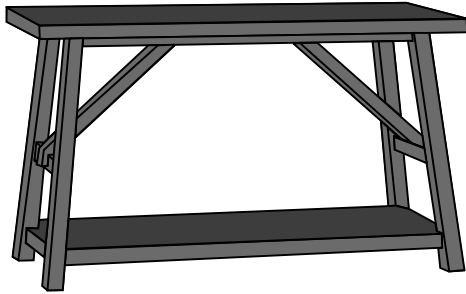

~ Console Table ~

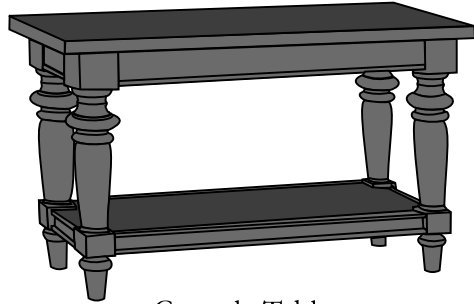

~ Console Table ~

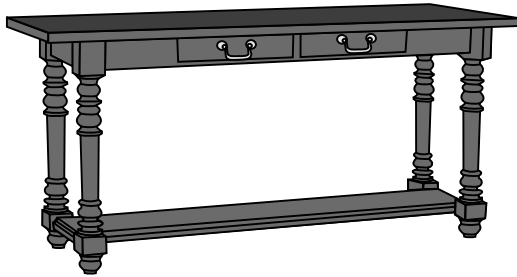

~ Console Table ~

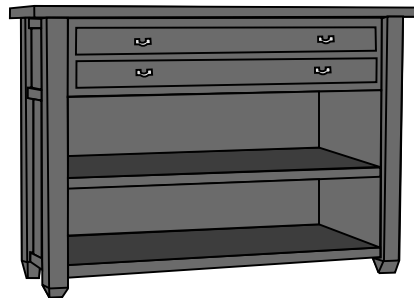

~ Console Table ~



~ Console Table ~

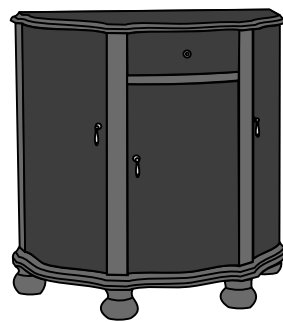

~ Console Table ~

Living Room Furniture

| Console Tables |

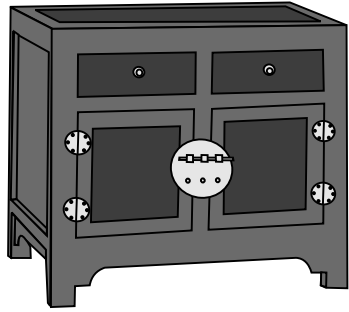

~ Console Table ~



~ Console Table ~

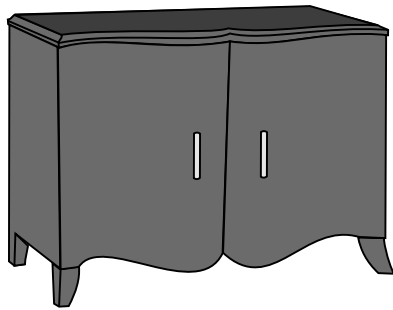

~ Console Table ~

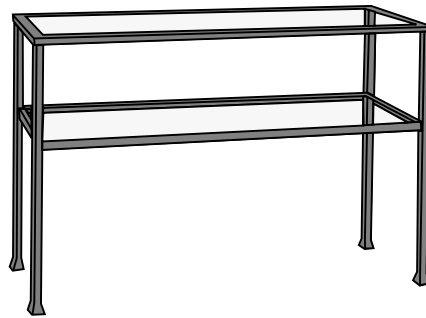

~ Console Table ~

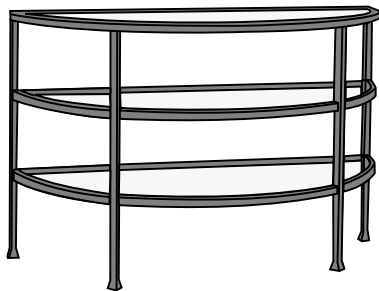

~ Console Table ~

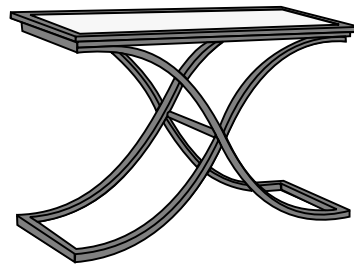

~ Console Table ~

Living Room Furniture

| Console Tables |



~ Console Table ~



~ Console Table ~

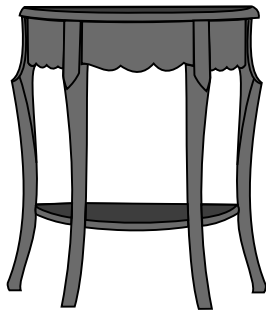

~ Console Table ~



~ Console Table ~



~ Console Table ~

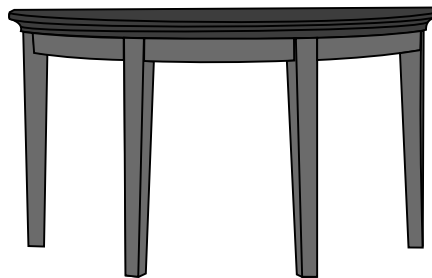

~ Console Table ~

Living Room Furniture

| Console Tables |

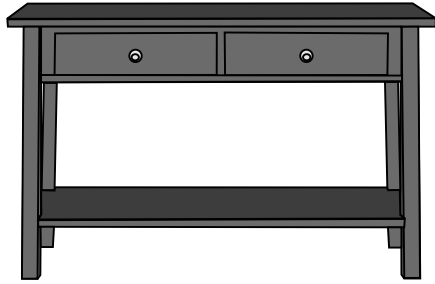

~ Console Table ~

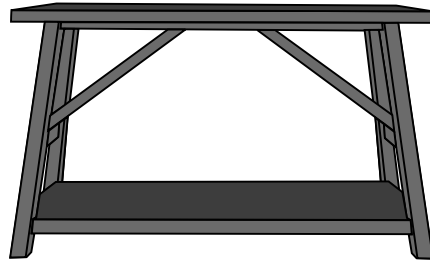

~ Console Table ~



~ Console Table ~



~ Console Table ~



~ Console Table ~

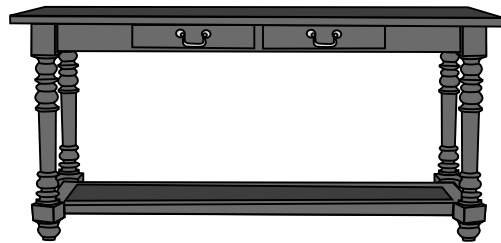

~ Console Table ~

Living Room Furniture

| Console Tables |

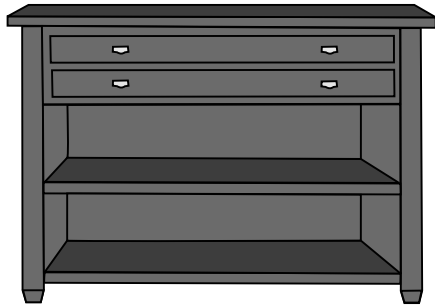

~ Console Table ~

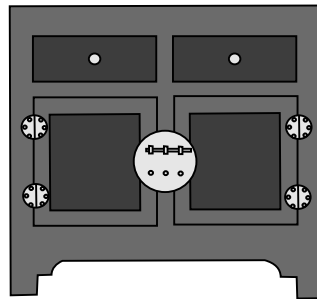

~ Console Table ~

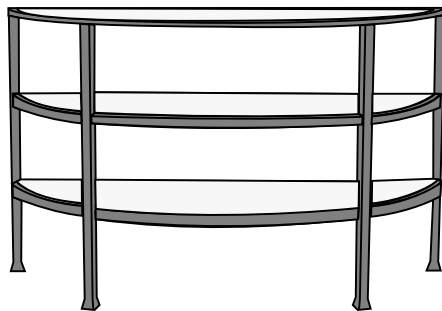

~ Console Table ~

Living Room Furniture

| Media and Storage |

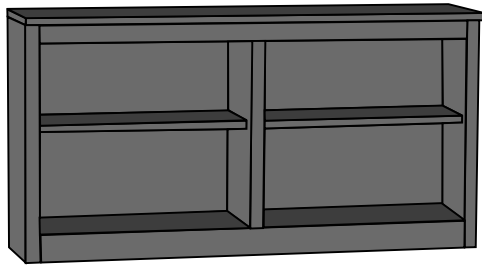

~ Bookcase ~

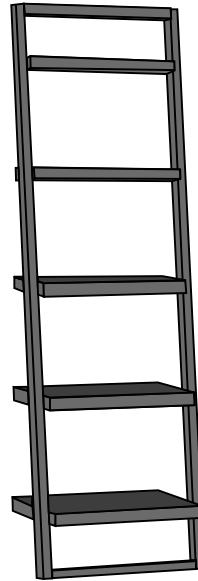

~ Bookcase ~

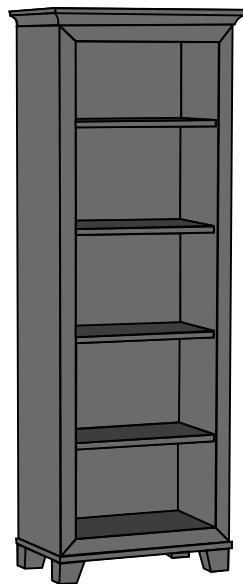

~ Bookcase ~

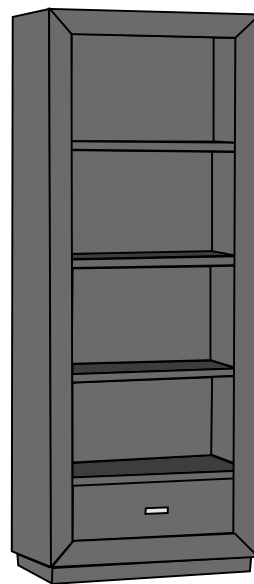

~ Bookcase ~

Living Room Furniture

| Media and Storage |

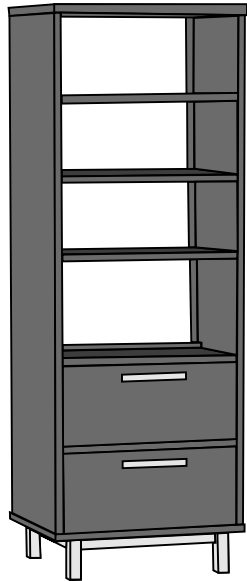

~ Bookcase ~

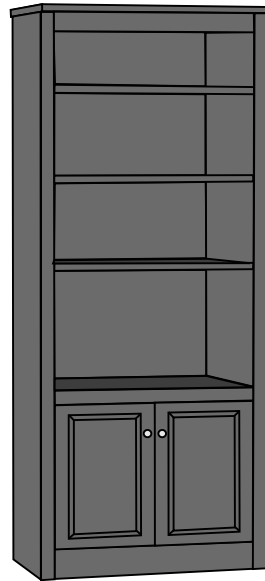

~ Bookcase ~

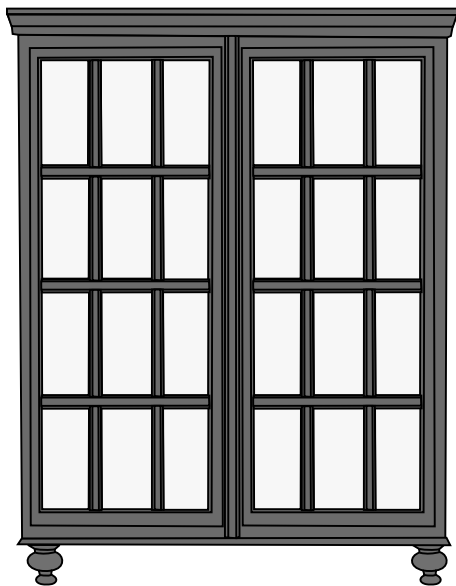

~ Bookcase ~

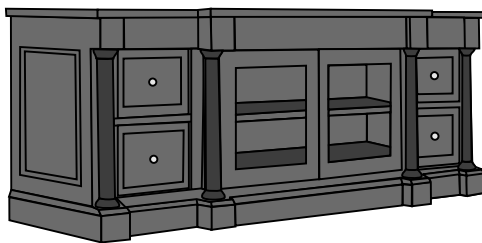

~ Media Cabinet ~

Living Room Furniture

| Media and Storage |

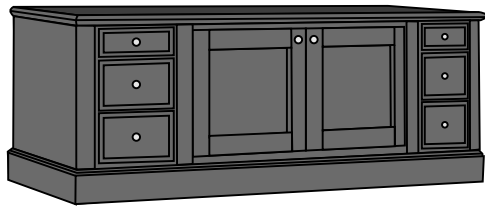

~ Media Cabinet ~

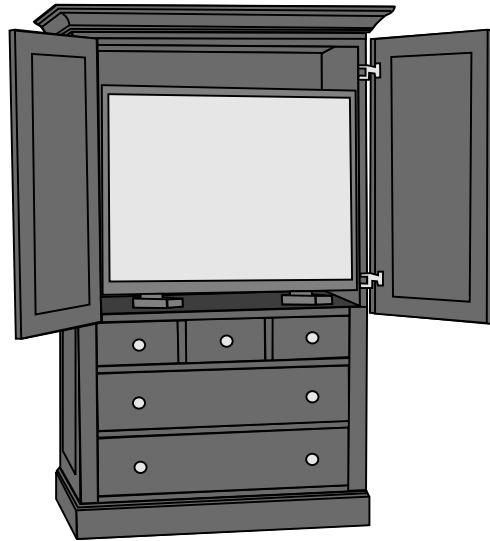

~ Media Cabinet ~

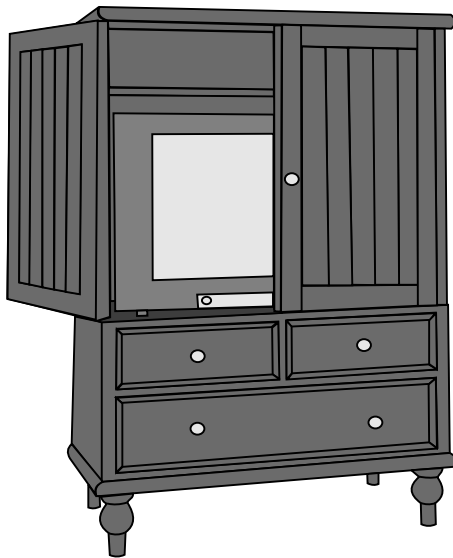

~ Media Cabinet ~

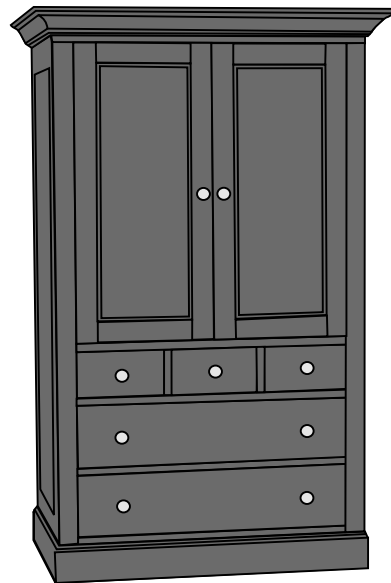

~ Media Cabinet ~

Living Room Furniture

| Media and Storage |



~ Media Cabinet ~

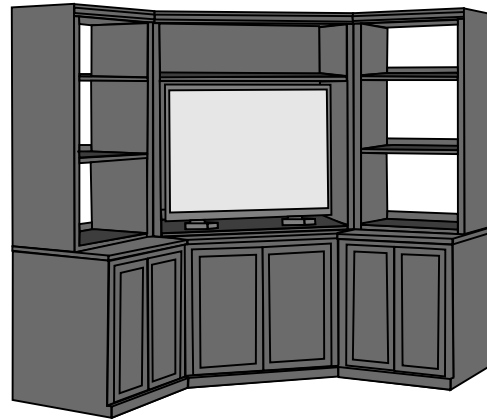

~ Media Cabinet ~

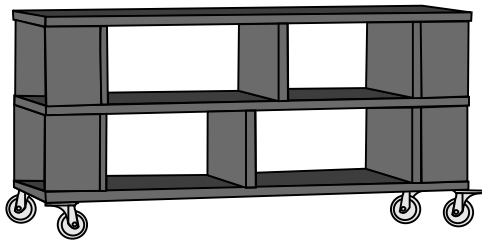

~ Media Stand ~

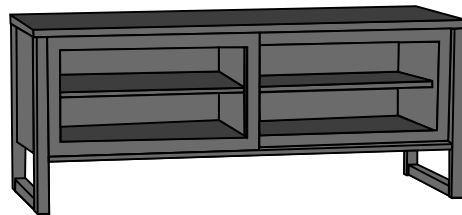

~ Media Stand ~

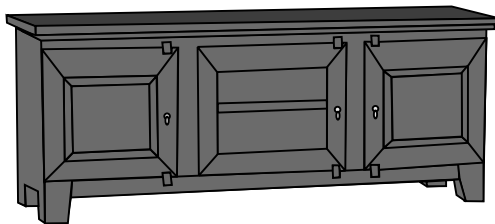

~ Media Stand ~

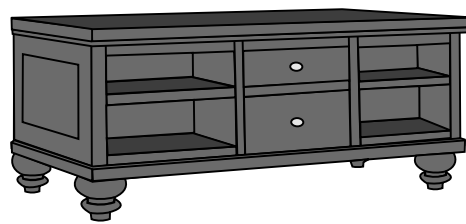

~ Media Stand ~

Living Room Furniture

| Media and Storage |

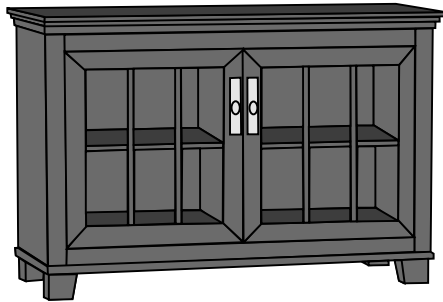

~ Media Stand ~

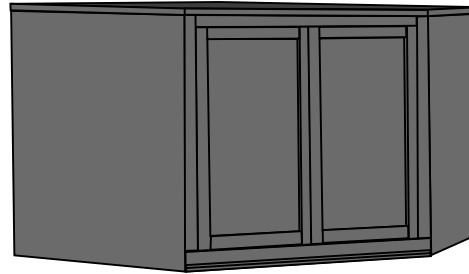

~ Media Stand ~

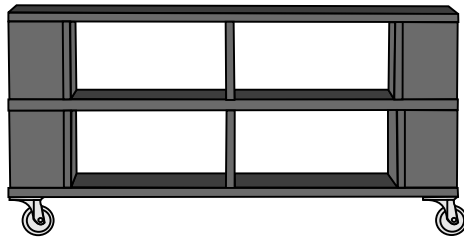

~ Media Stand ~

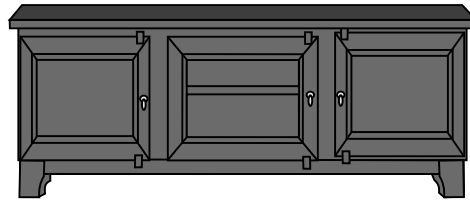

~ Media Stand ~

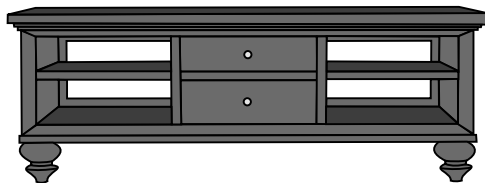

~ Media Stand ~

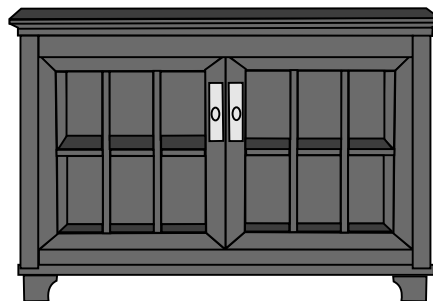

~ Media Stand ~

Living Room Furniture

| Ottomans |

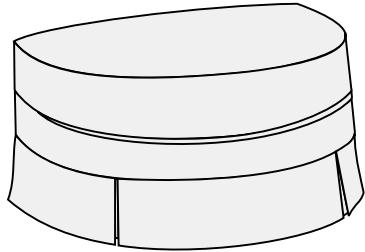

~ Half Circle w/Skirt Ottoman ~



~ Rectangle Ottoman ~

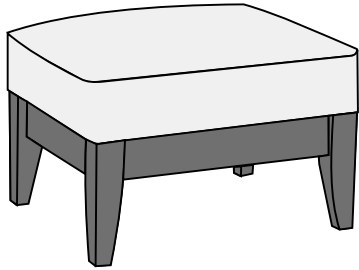

~ Rectangle Ottoman ~

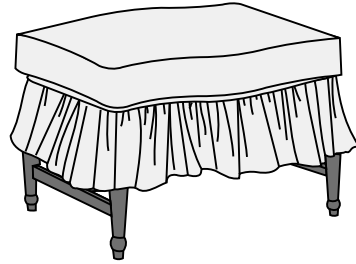

~ Rectangle Ottoman ~

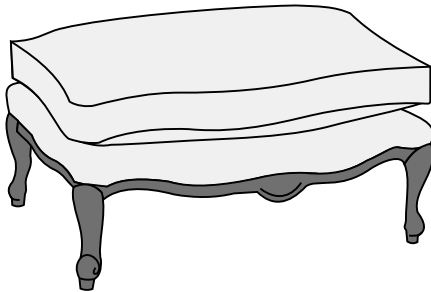

~ Rectangle Ottoman ~

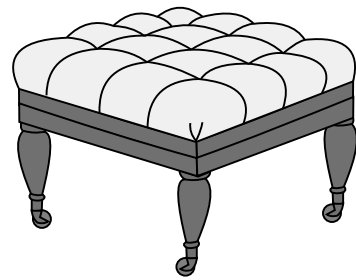

~ Rectangle Ottoman ~

Living Room Furniture

| Ottomans |

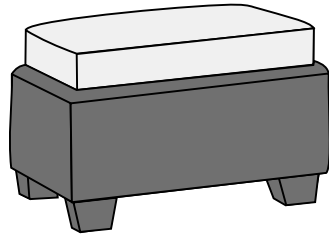

~ Rectangle Ottoman ~

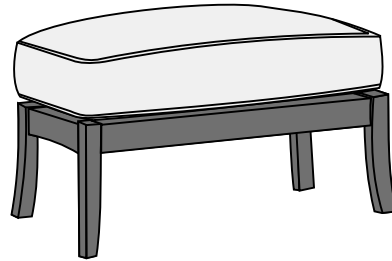

~ Rectangle Ottoman ~

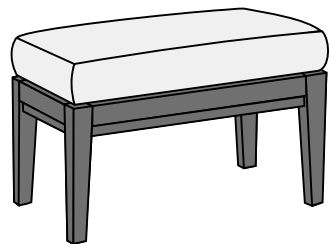

~ Rectangle Ottoman ~

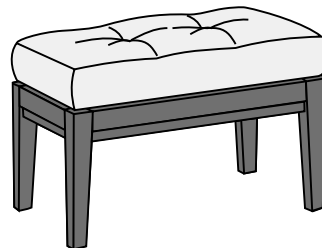

~ Rectangle Ottoman ~

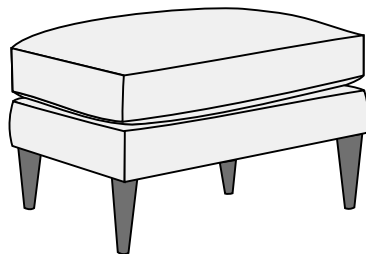

~ Rectangle Ottoman ~

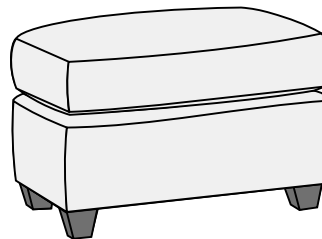

~ Rectangle Ottoman ~

Living Room Furniture

| Ottomans |

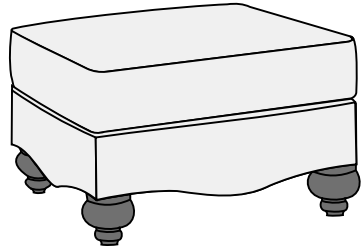

~ Rectangle Ottoman ~

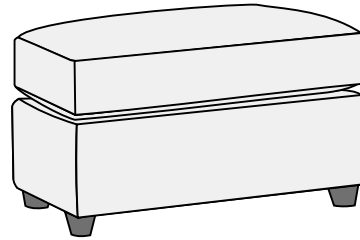

~ Rectangle Ottoman ~

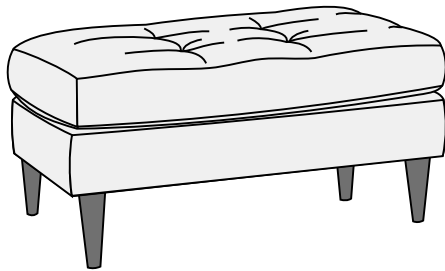

~ Rectangle Ottoman ~

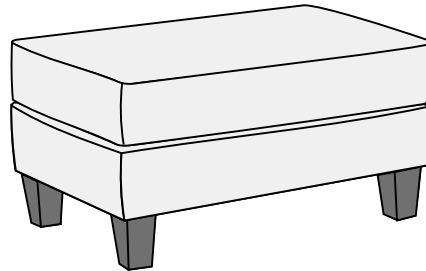

~ Rectangle Ottoman ~

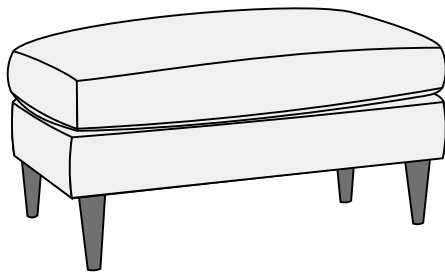

~ Rectangle Ottoman ~

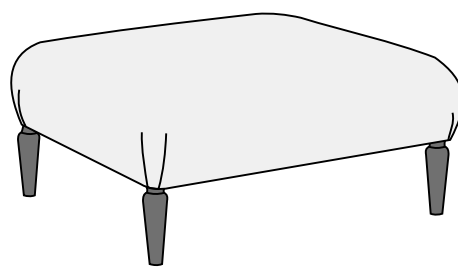

~ Rectangle Ottoman ~

Living Room Furniture

| Ottomans |

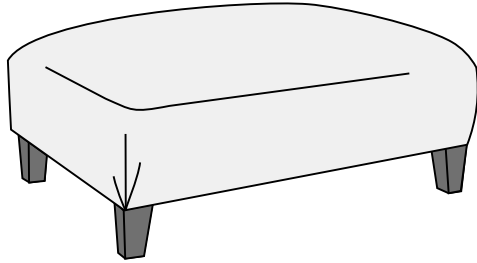

~ Rectangle Ottoman ~

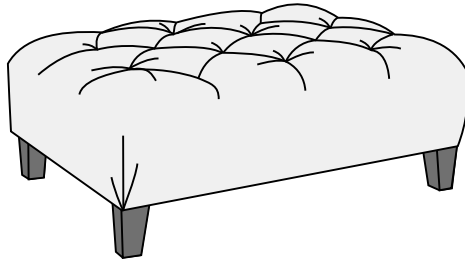

~ Rectangle Ottoman ~

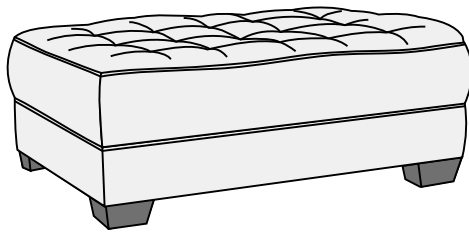

~ Rectangle Ottoman ~

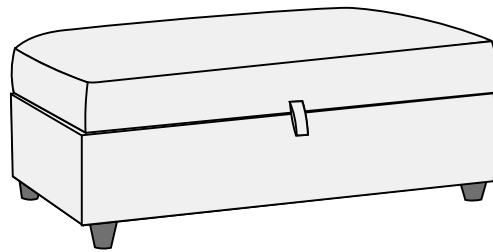

~ Rectangle Ottoman ~

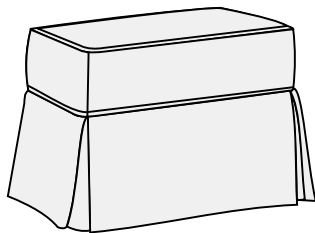

~ Rectangle w/Skirt Ottoman ~

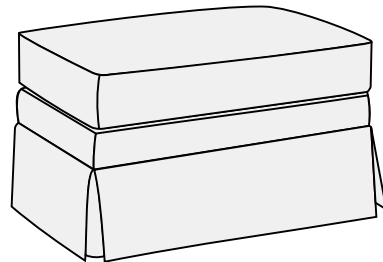

~ Rectangle w/Skirt Ottoman ~

Living Room Furniture

| Ottomans |

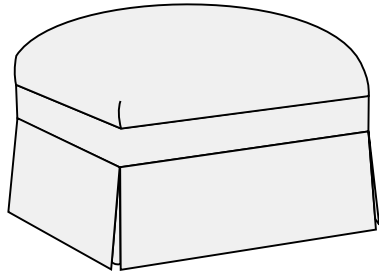

~ Rectangle w/Skirt Ottoman ~

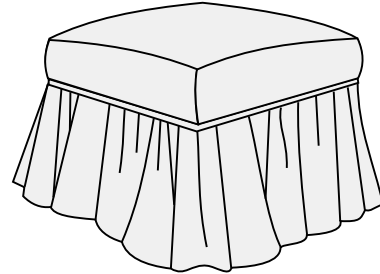

~ Rectangle w/Skirt Ottoman ~

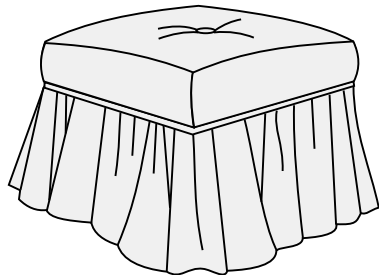

~ Rectangle w/Skirt Ottoman ~

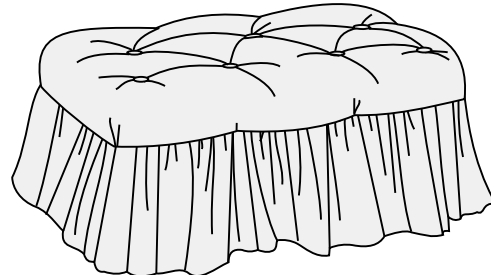

~ Rectangle w/Skirt Ottoman ~

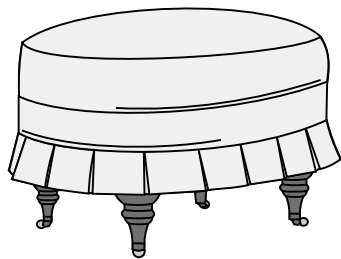

~ Round Ottoman ~

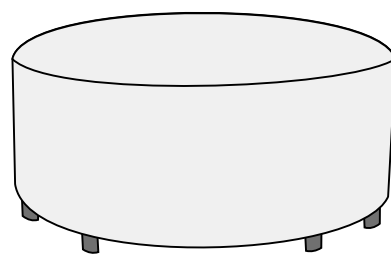

~ Round Ottoman ~

Living Room Furniture

| Ottomans |

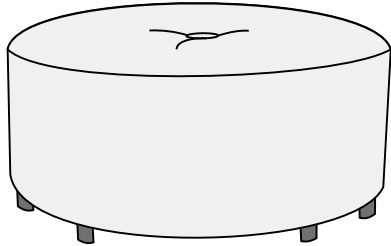

~ Round Ottoman ~

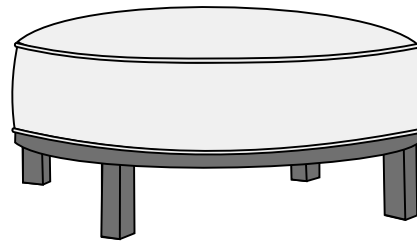

~ Round Ottoman ~

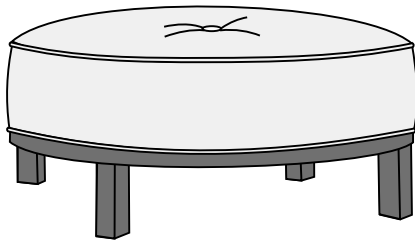

~ Round Ottoman ~

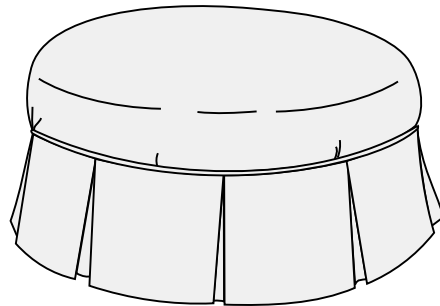

~ Round w/Skirt Ottoman ~

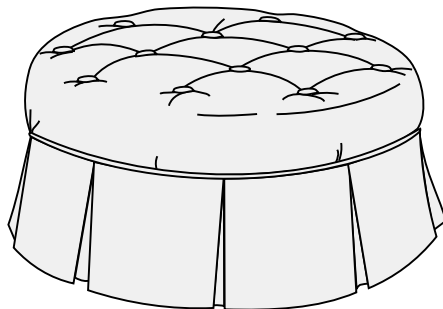

~ Round w/Skirt Ottoman ~



~ Wicker Ottoman ~

Living Room Furniture

| Side Tables |



~ Side Table ~

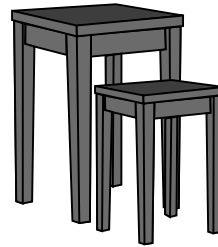

~ Side Table ~

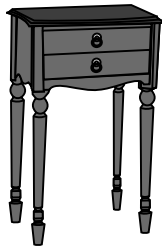

~ Side Table ~

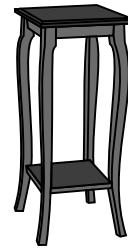

~ Side Table ~



~ Side Table ~



~ Side Table ~

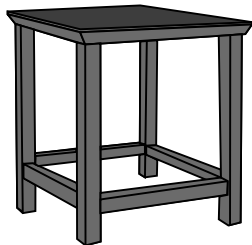

~ Side Table ~

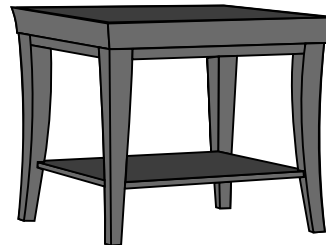

~ Side Table ~

Living Room Furniture

| Side Tables |

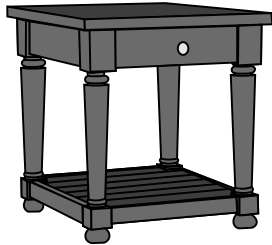

~ Side Table ~



~ Side Table ~



~ Side Table ~



~ Side Table ~



~ Side Table ~

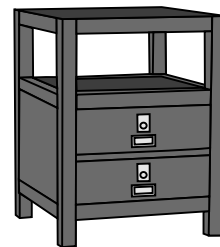

~ Side Table ~

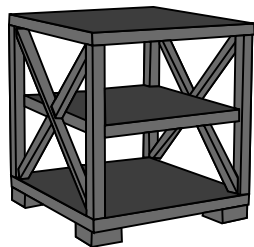

~ Side Table ~

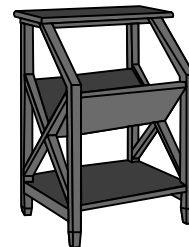

~ Side Table ~

Living Room Furniture

| Side Tables |

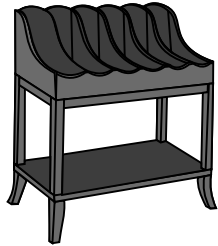

~ Side Table ~



~ Side Table ~

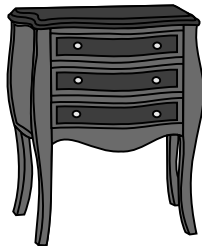

~ Side Table ~

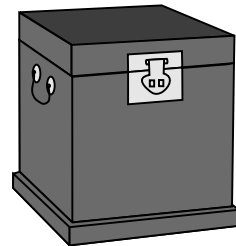

~ Side Table ~

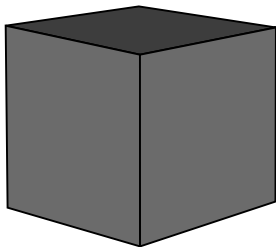

~ Side Table ~

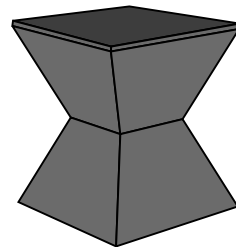

~ Side Table ~

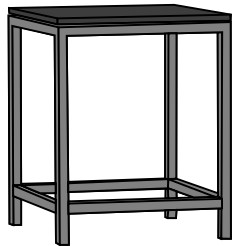

~ Side Table ~

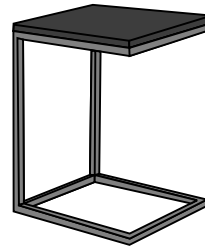

~ Side Table ~

Living Room Furniture

| Side Tables |

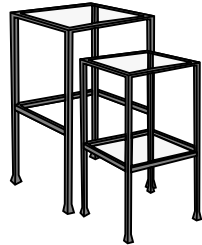

~ Side Table ~

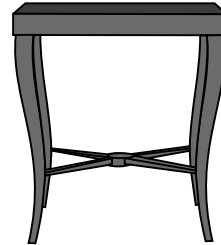

~ Side Table ~

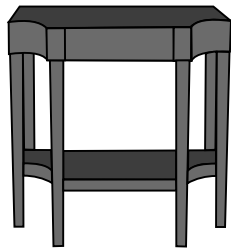

~ Side Table ~



~ Side Table ~

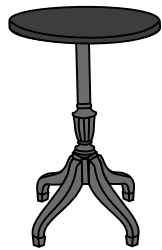

~ Side Table (Round) ~

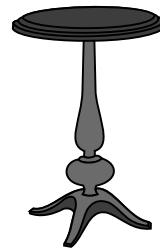

~ Side Table (Round) ~



~ Side Table (Round) ~

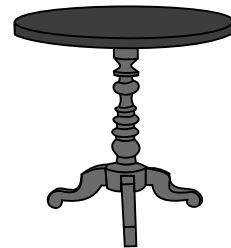

~ Side Table (Round) ~

Living Room Furniture

| Side Tables |

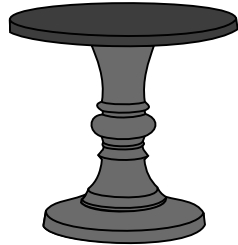

~ Side Table (Round) ~

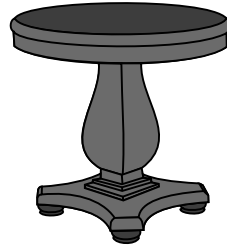

~ Side Table (Round) ~

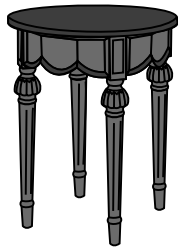

~ Side Table (Round) ~



~ Side Table (Round) ~

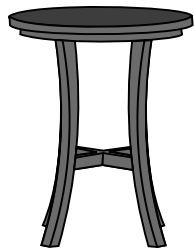

~ Side Table (Round) ~



~ Side Table (Round) ~

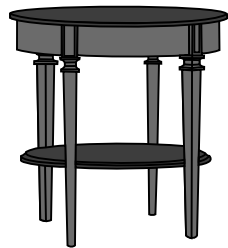

~ Side Table (Round) ~



~ Side Table (Round) ~

Living Room Furniture

| Side Tables |



~ Side Table (Round) ~

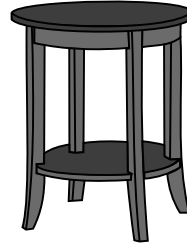

~ Side Table (Round) ~

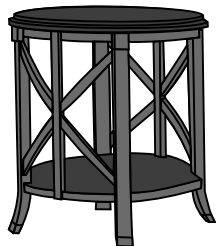

~ Side Table (Round) ~



~ Side Table (Round) ~

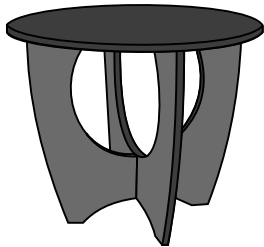

~ Side Table (Round) ~

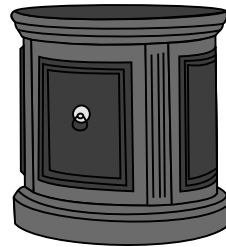

~ Side Table (Round) ~

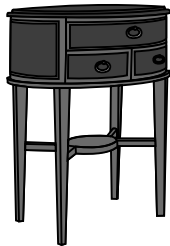

~ Side Table (Round) ~

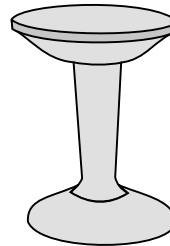

~ Side Table (Round) ~

Living Room Furniture

| Side Tables |

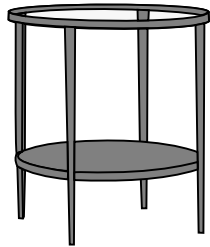

~ Side Table (Round) ~

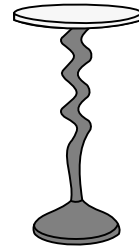

~ Side Table (Round) ~

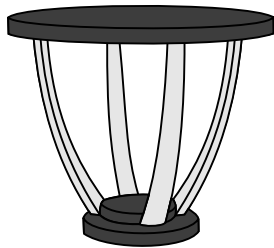

~ Side Table (Round) ~

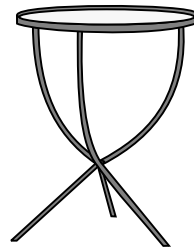

~ Side Table (Round) ~



~ Side Table (Round) ~

Living Room Furniture

| Sofas |

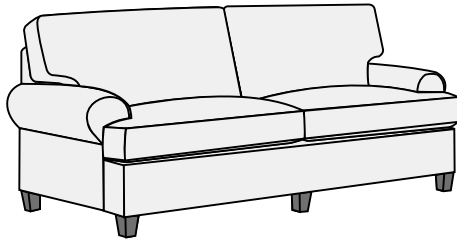

~ Loose Back w/Feet ~

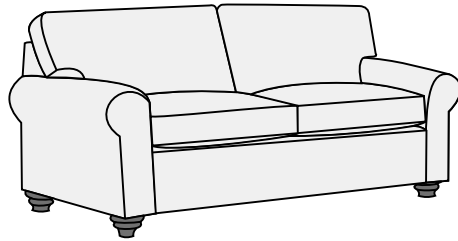

~ Loose Back w/Feet ~

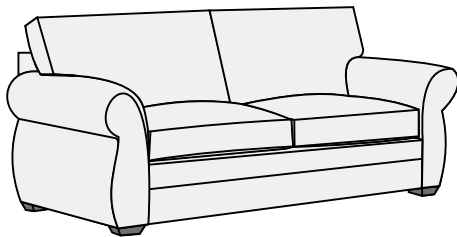

~ Loose Back w/Feet ~

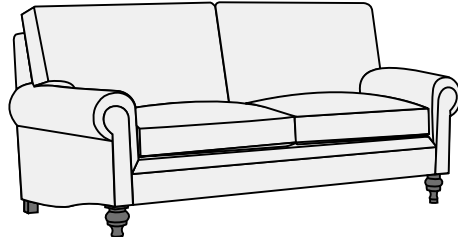

~ Loose Back w/Feet ~

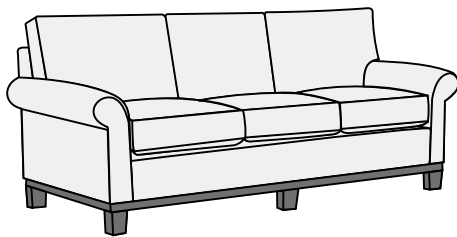

~ Loose Back w/Feet ~

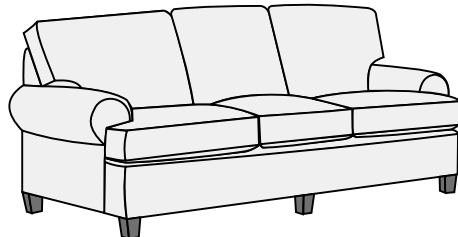

~ Loose Back w/Feet ~

Living Room Furniture

| Sofas |

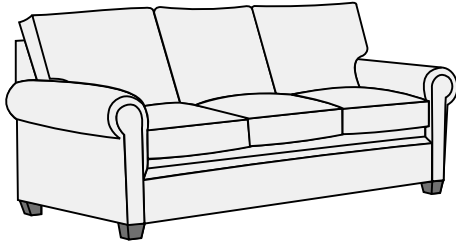

~ Loose Back w/Feet ~

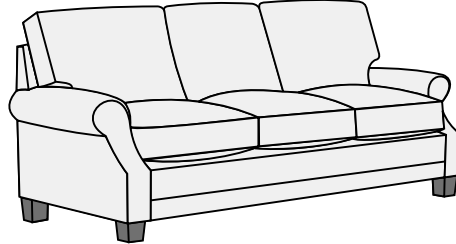

~ Loose Back w/Feet ~

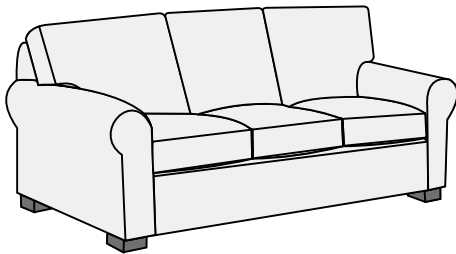

~ Loose Back w/Feet ~

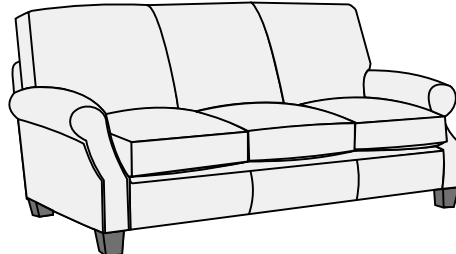

~ Loose Back w/Feet ~

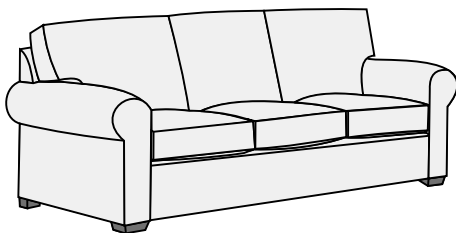

~ Loose Back w/Feet ~

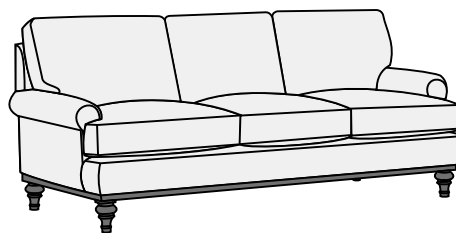

~ Loose Back w/Feet ~

Living Room Furniture

| Sofas |

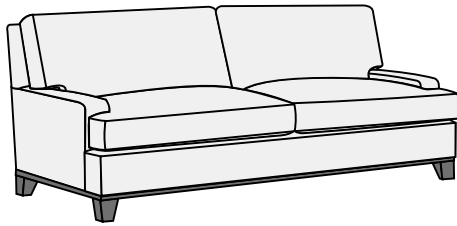

~ Loose Back w/Feet ~

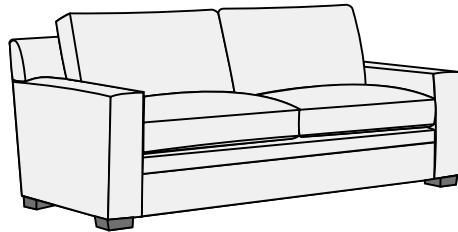

~ Loose Back w/Feet ~

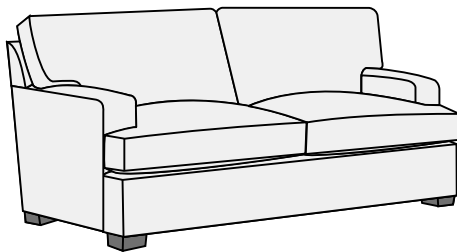

~ Loose Back w/Feet ~

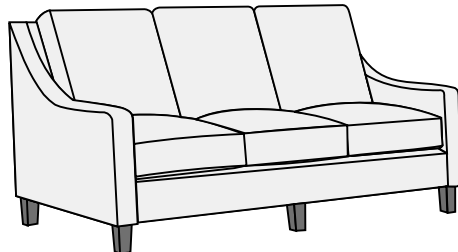

~ Loose Back w/Feet ~

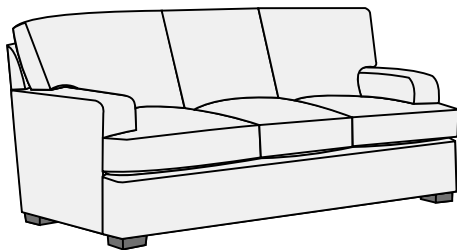

~ Loose Back w/Feet ~

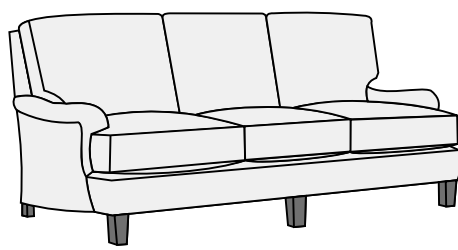

~ Loose Back w/Feet ~

Living Room Furniture

| Sofas |

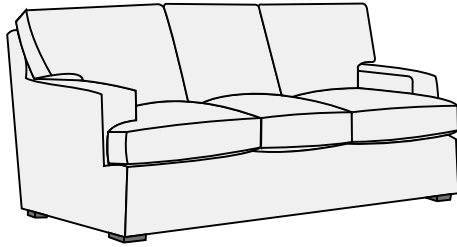

~ Loose Back w/Feet ~

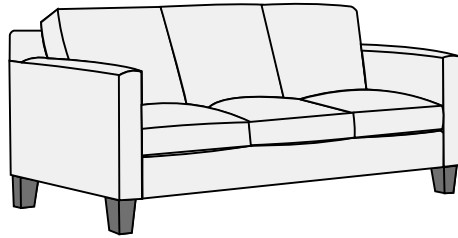

~ Loose Back w/Feet ~

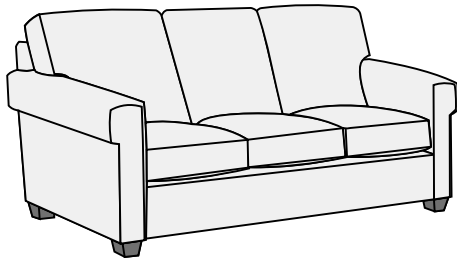

~ Loose Back w/Feet ~

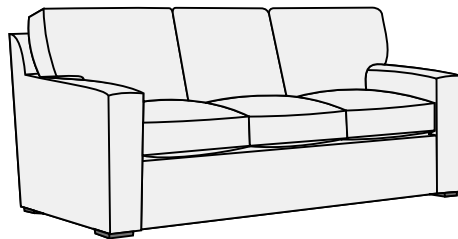

~ Loose Back w/Feet ~

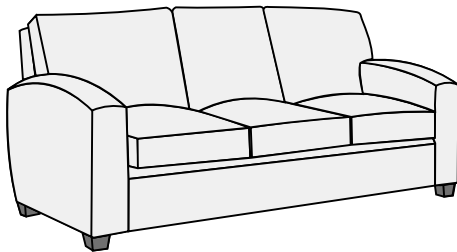

~ Loose Back w/Feet ~

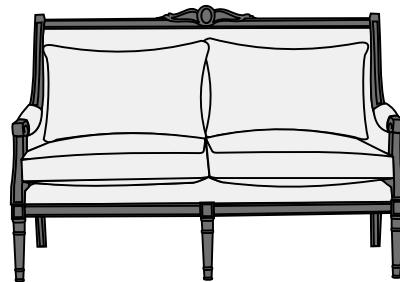

~ Loose Back w/Feet ~

Living Room Furniture

| Sofas |

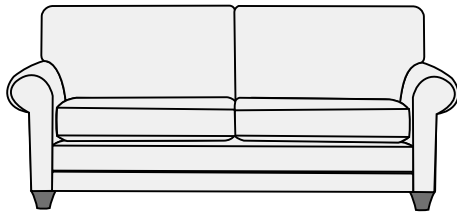

~ Loose Back w/Feet ~

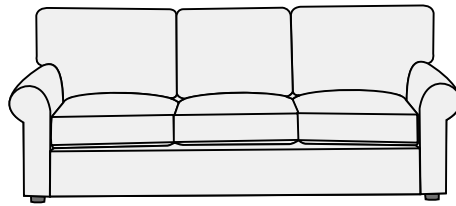

~ Loose Back w/Feet ~

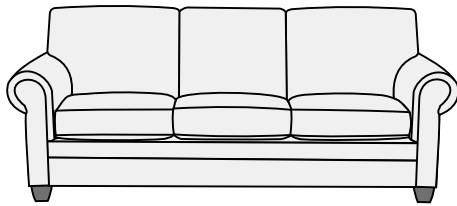

~ Loose Back w/Feet ~

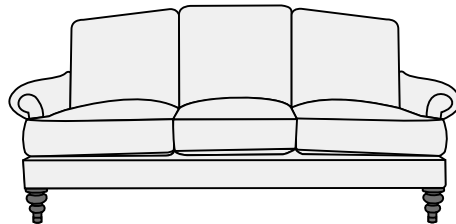

~ Loose Back w/Feet ~

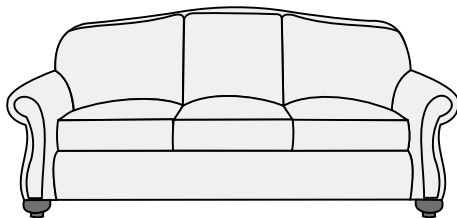

~ Loose Back w/Feet ~

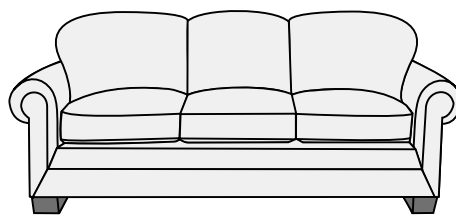

~ Loose Back w/Feet ~

Living Room Furniture

| Sofas |

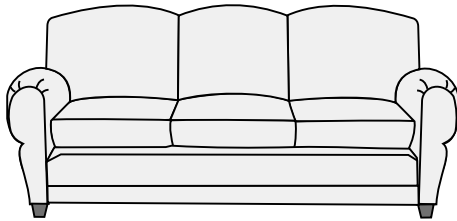

~ Loose Back w/Feet ~

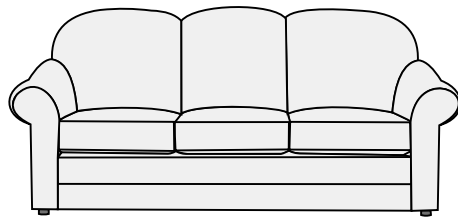

~ Loose Back w/Feet ~

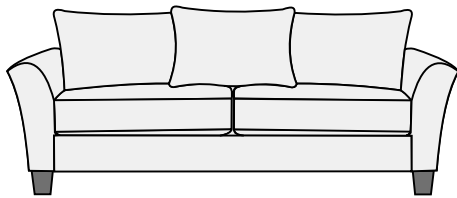

~ Loose Back w/Feet ~

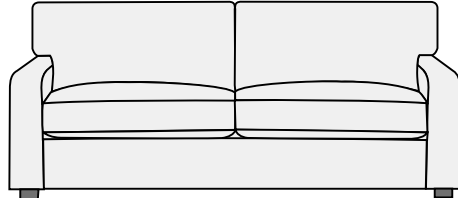

~ Loose Back w/Feet ~

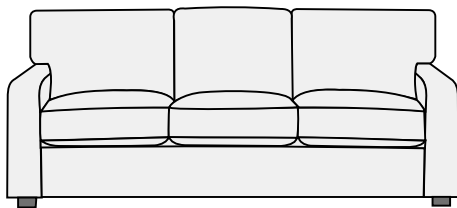

~ Loose Back w/Feet ~

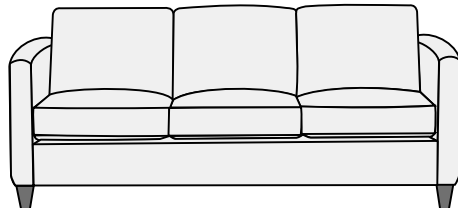

~ Loose Back w/Feet ~

Living Room Furniture

| Sofas |

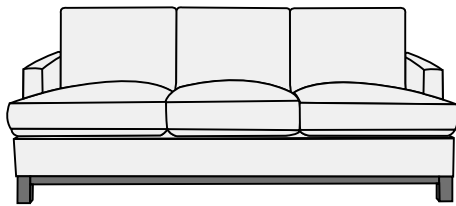

~ Loose Back w/Feet ~

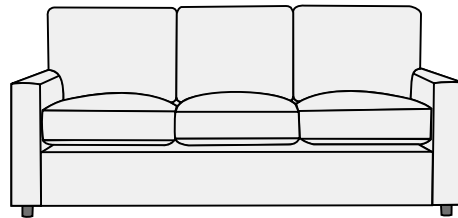

~ Loose Back w/Feet ~

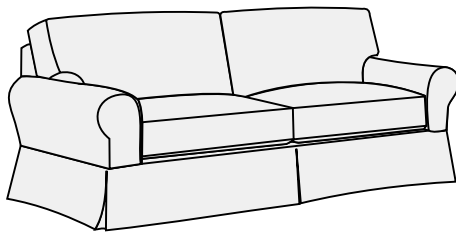

~ Loose Back w/Skirt ~

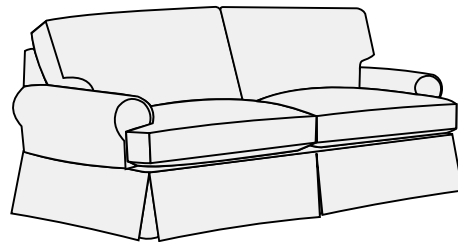

~ Loose Back w/Skirt ~

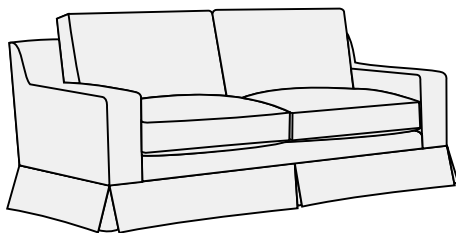

~ Loose Back w/Skirt ~

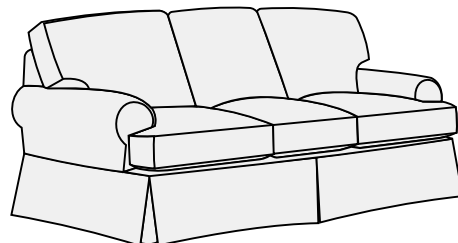

~ Loose Back w/Skirt ~

Living Room Furniture

| Sofas |

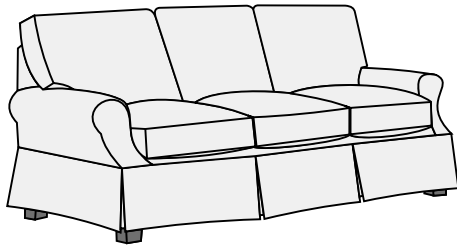

~ Loose Back w/Skirt ~

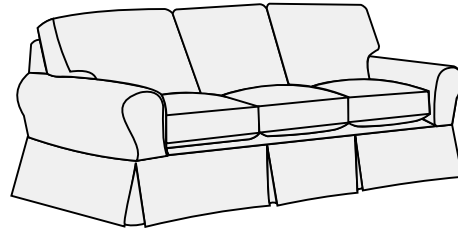

~ Loose Back w/Skirt ~

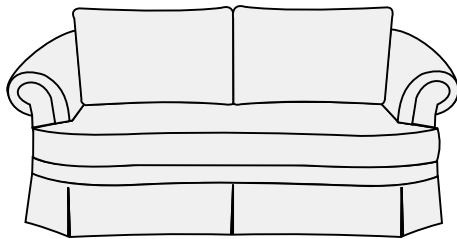

~ Loose Back w/Skirt ~

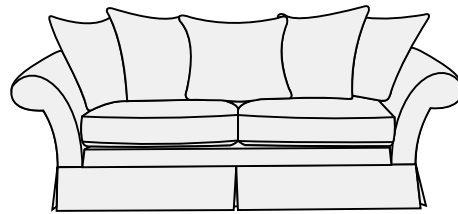

~ Loose Back w/Skirt ~

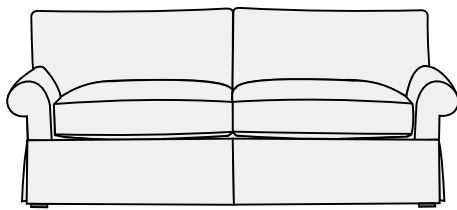

~ Loose Back w/Skirt ~

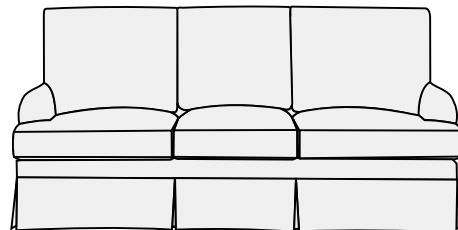

~ Loose Back w/Skirt ~

Living Room Furniture

| Sofas |

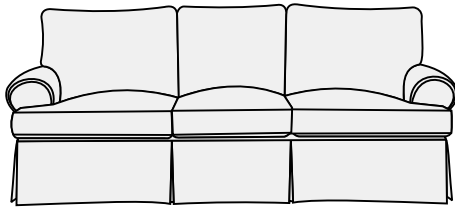

~ Loose Back w/Skirt ~

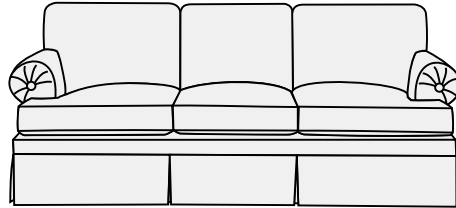

~ Loose Back w/Skirt ~

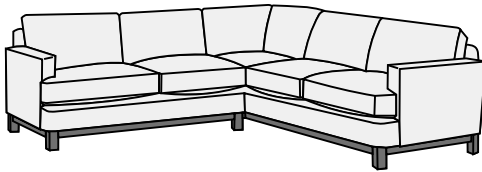

~ Sectional w/Feet ~

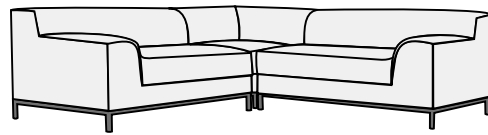

~ Sectional w/Feet ~



~ Sectional w/Feet ~

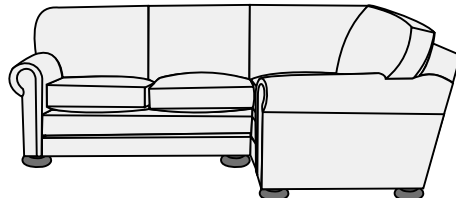

~ Sectional w/Feet ~

Living Room Furniture

| Sofas |

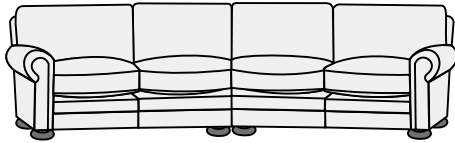

~ Sectional w/Feet ~

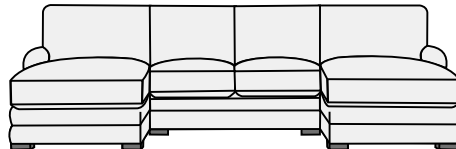

~ Sectional w/Feet ~

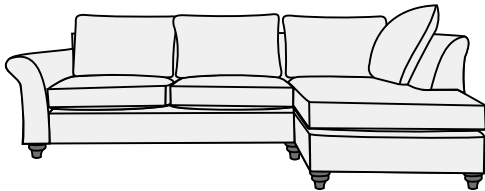

~ Sectional w/Feet ~

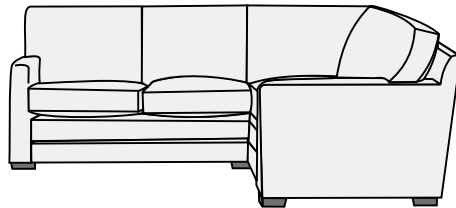

~ Sectional w/Feet ~

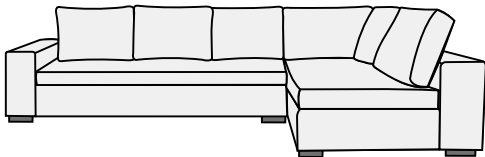

~ Sectional w/Feet ~

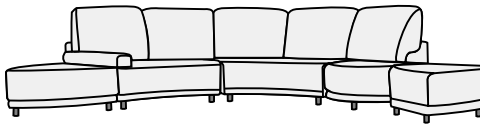

~ Sectional w/Feet ~

Living Room Furniture

| Sofas |

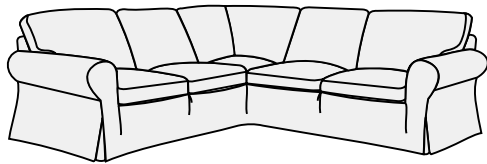

~ Sectional w/Skirt ~

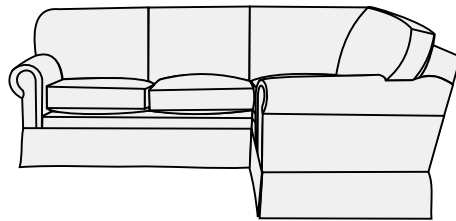

~ Sectional w/Skirt ~

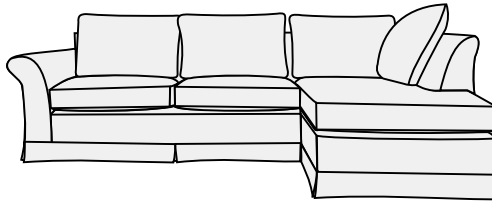

~ Sectional w/Skirt ~

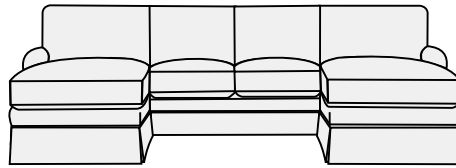

~ Sectional w/Skirt ~

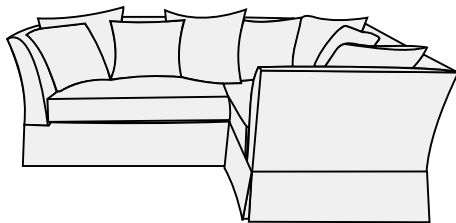

~ Sectional w/Skirt ~

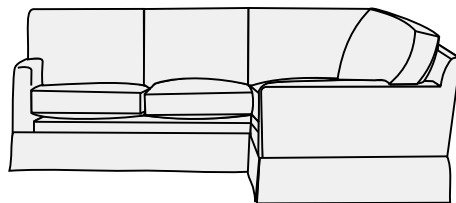

~ Sectional w/Skirt ~

Living Room Furniture

| Sofas |

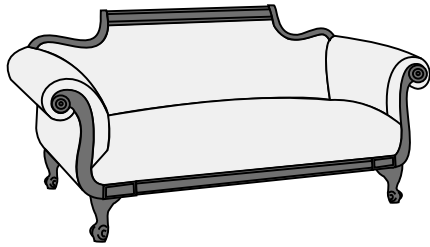

~ Tight Back w/Feet ~

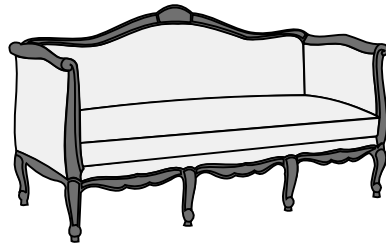

~ Tight Back w/Feet ~

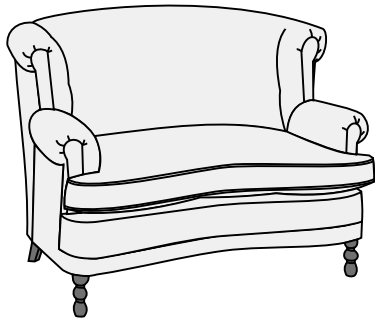

~ Tight Back w/Feet ~

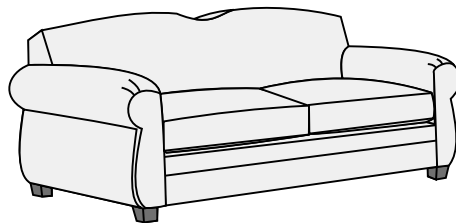

~ Tight Back w/Feet ~

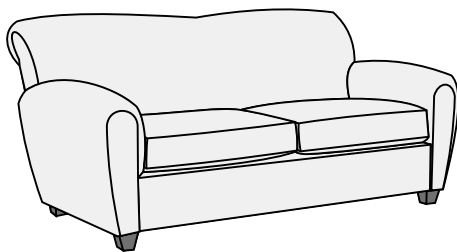

~ Tight Back w/Feet ~

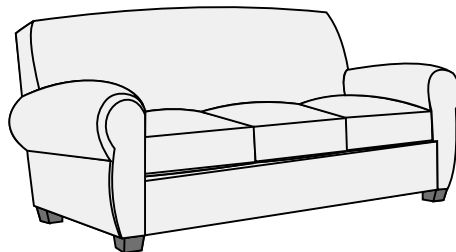

~ Tight Back w/Feet ~

Living Room Furniture

| Sofas |

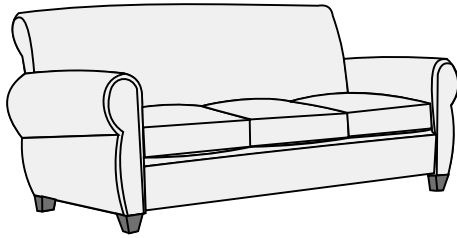

~ Tight Back w/Feet ~

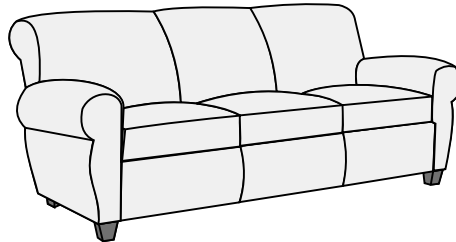

~ Tight Back w/Feet ~

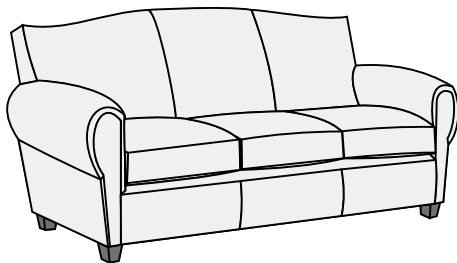

~ Tight Back w/Feet ~

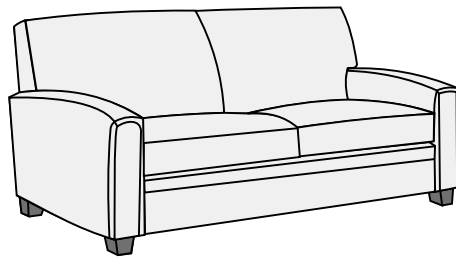

~ Tight Back w/Feet ~

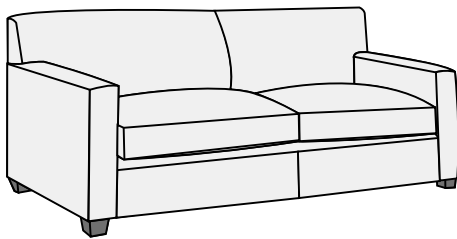

~ Tight Back w/Feet ~

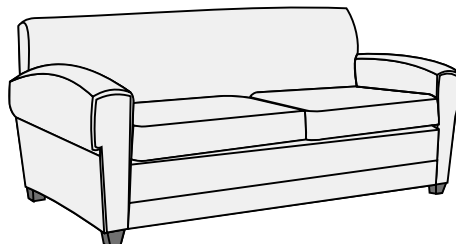

~ Tight Back w/Feet ~

Living Room Furniture

| Sofas |

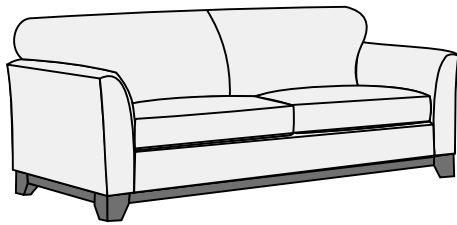

~ Tight Back w/Feet ~

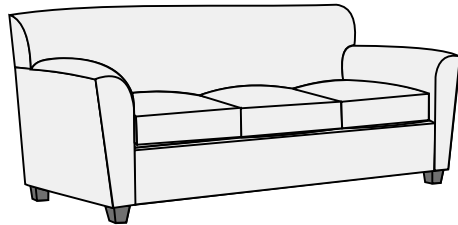

~ Tight Back w/Feet ~

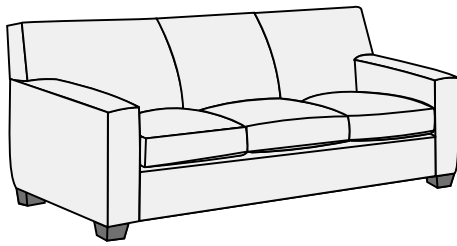

~ Tight Back w/Feet ~

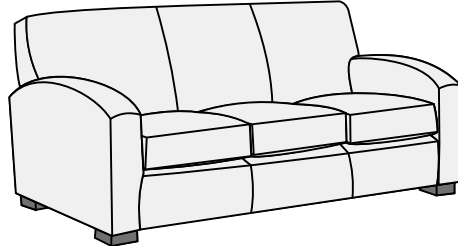

~ Tight Back w/Feet ~

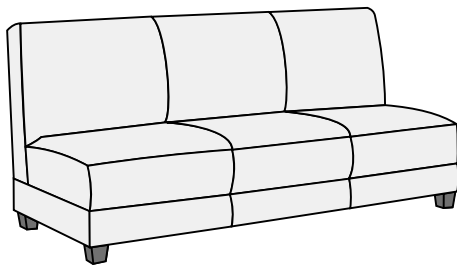

~ Tight Back w/Feet ~



~ Tight Back w/Feet ~

Living Room Furniture

| Sofas |

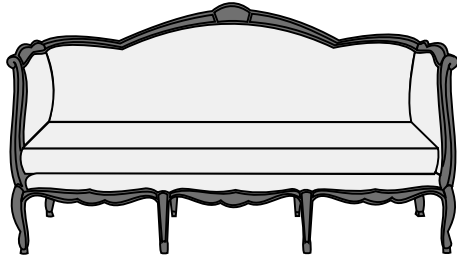

~ Tight Back w/Feet ~

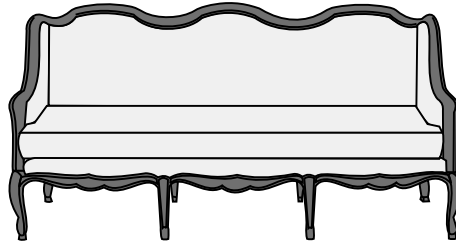

~ Tight Back w/Feet ~

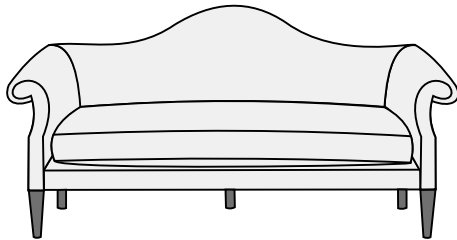

~ Tight Back w/Feet ~

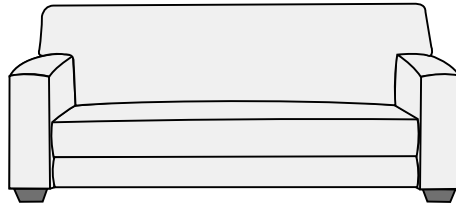

~ Tight Back w/Feet ~

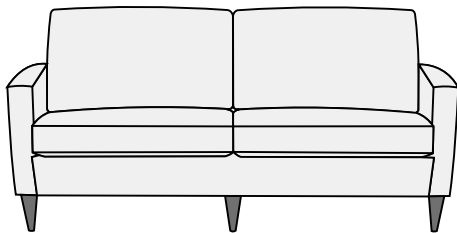

~ Tight Back w/Feet ~

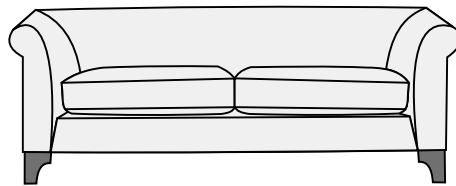

~ Tight Back w/Feet ~

Living Room Furniture

| Sofas |

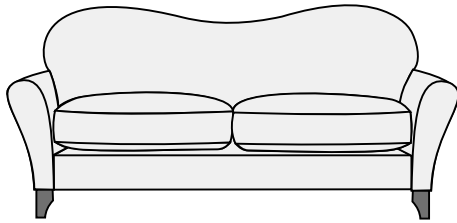

~ Tight Back w/Feet ~

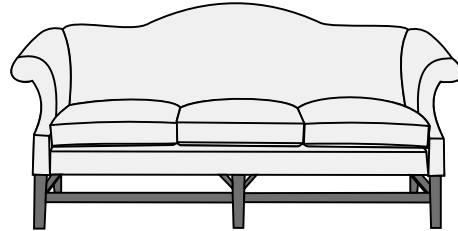

~ Tight Back w/Feet ~

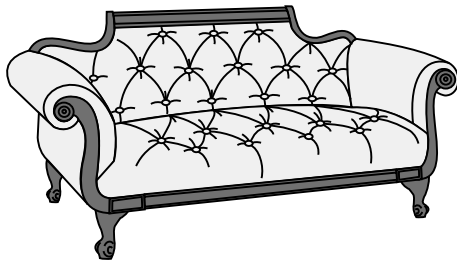

~ Tufted w/Feet ~

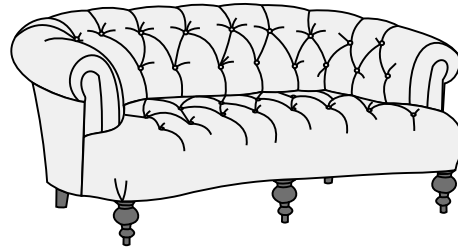

~ Tufted w/Feet ~

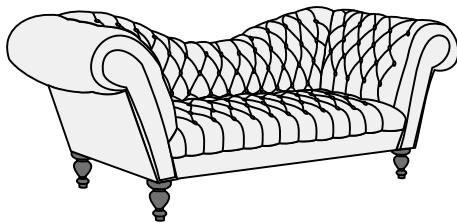

~ Tufted w/Feet ~

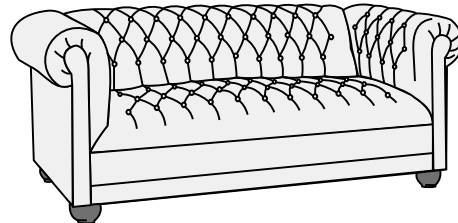

~ Tufted w/Feet ~

Living Room Furniture

| Sofas |

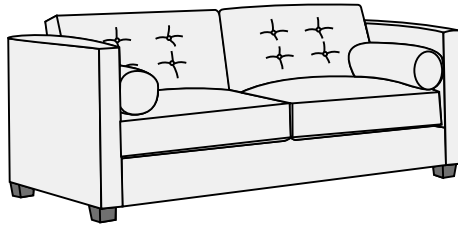

~ Tufted w/Feet ~

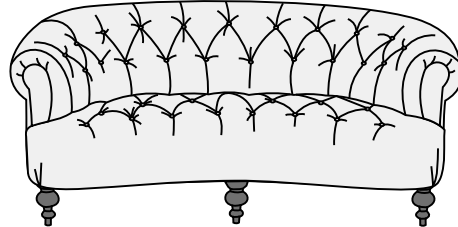

~ Tufted w/Feet ~

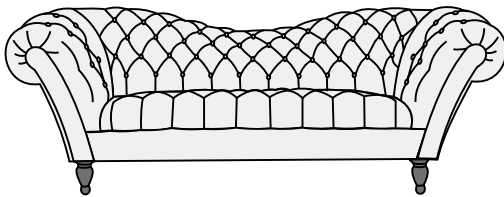

~ Tufted w/Feet ~

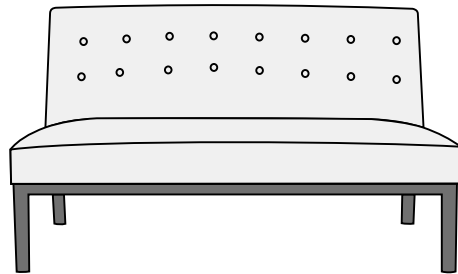

~ Tufted w/Feet ~

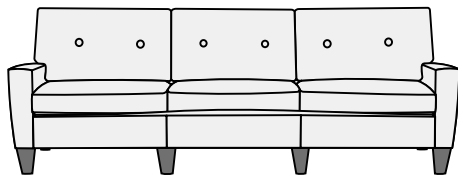

~ Tufted w/Feet ~

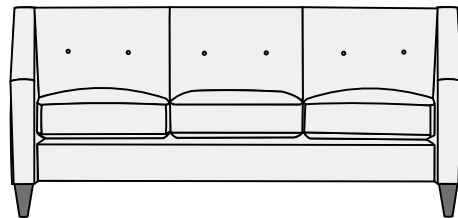

~ Tufted w/Feet ~



Style:

Space
— Planning



Space Planning

| Appliances |

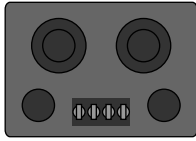

~ Cook Top ~
(36x21)

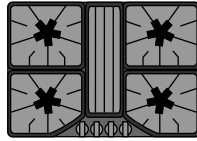

~ Cook Top ~
(30x21)

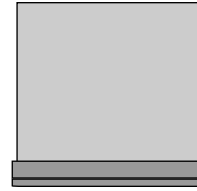

~ Dishwasher ~
(23x22)

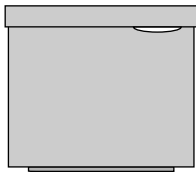

~ Dryer ~
(29x25)

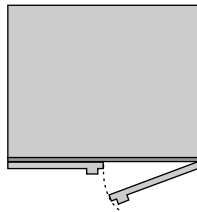

~ Fridge ~
(33x29)



~ Grill ~
(15x21)

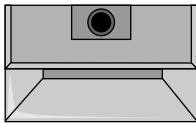

~ Hood (Cabinet) ~
(30x20)

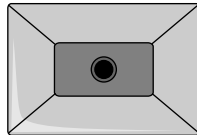

~ Hood (Island) ~
(35x24)

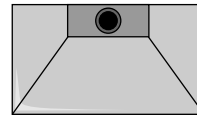

~ Hood (Wall) ~
(35x20)

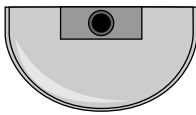

~ Hood (Wall) ~
(35x19)

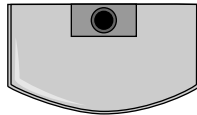

~ Hood (Wall) ~
(35x20)



~ Microwave ~
(29x16)

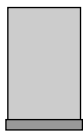

~ Trash Compactor ~
(15x24)

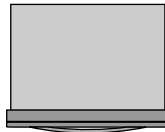

~ Wall Oven ~
(29x23)

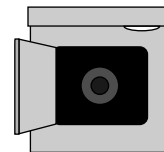

~ Washer ~
(27x25)

Space Planning

| Architectural Elements |

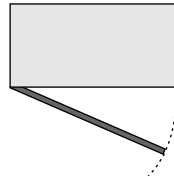

~ Closet ~
(24x12)

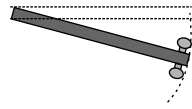

~ Door ~
(27)



~ Door (Bifold) ~
(48)

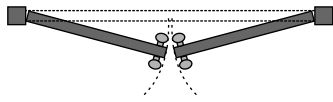

~ Door (Double) ~
(55)



~ Door (Pocket) ~
(24)



~ Door (Opening) ~
(36)

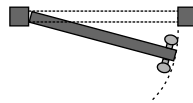

~ Door w/Jamb ~
(30)

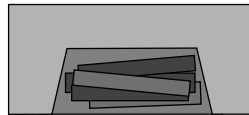

~ Fireplace ~



~ Mantel ~



~ Radiator ~

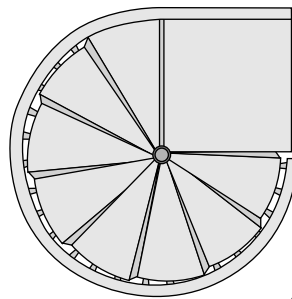

~ Stairs ~

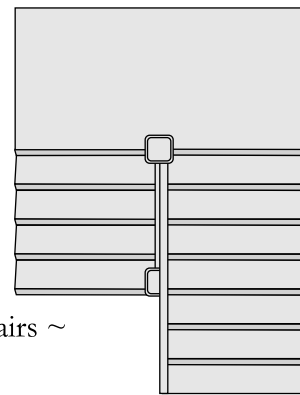

~ Walls ~



~ Windows ~



~ Symbols ~

Space Planning

| Beds |



~ Bassinet ~
(20x33)

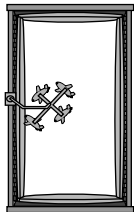

~ Crib ~
(32x52)



~ Crib (Round) ~
(45x43)

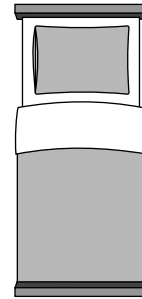

~ Youth ~
(33x73)

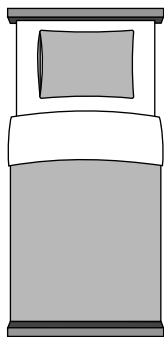

~ Single ~
(39x82)

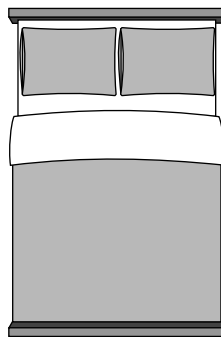

~ Double ~
(54x82)

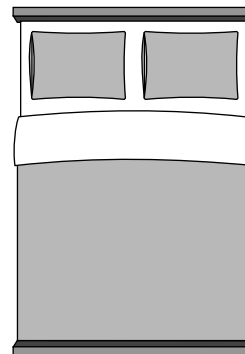

~ Queen ~
(60x87)

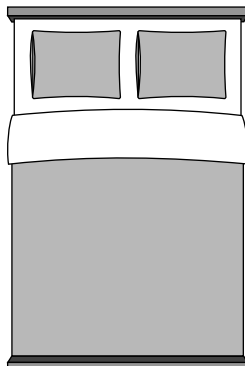

~ California Queen ~
(60x91)

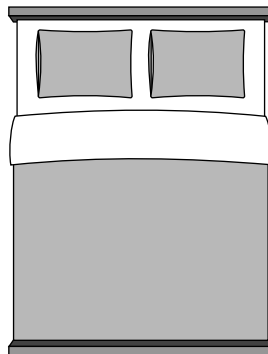

~ Olympic Queen ~
(66x87)

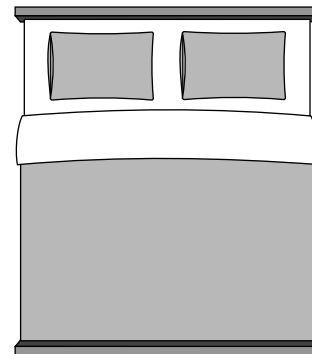

~ King ~
(76x87)

~ 153 ~

Space Planning

| Benches and Ottomans |



~ Bench ~
(20x15)

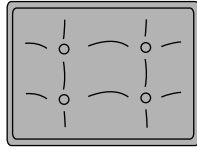

~ Bench Tufted ~
(20x15)

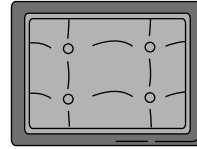

~ Bench Tufted ~
(20x15)

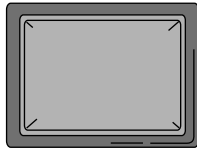

~ Bench w/Wood ~
(20x15)



~ Bench w/Wood ~
(20x15)

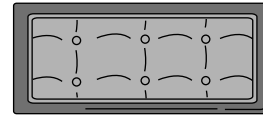

~ Bench Tufted ~
(28x12)

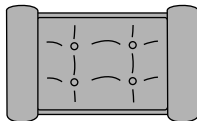

~ Bench Tufted ~
(28x17)

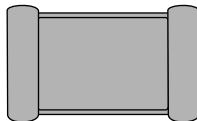

~ Bench w/Arms ~
(28x17)

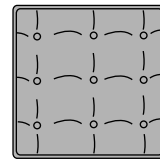

~ Ottoman Tufted ~
(22x22)

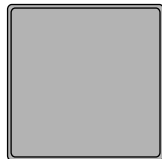

~ Ottoman ~
(22x22)

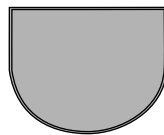

~ Ottoman Curved ~
(30x24)

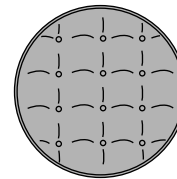

~ Ottoman Round ~
(32x32)

Space Planning

| Cabinets and Counters |



~ Base Cabinet ~
(9x24)



~ Base Cabinet ~
(15x24)



~ Base Cabinet ~
(21x24)



~ Top Cabinet ~
(9x12)



~ Top Cabinet ~
(15x12)



~ Top Cabinet ~
(21x12)

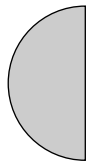

~ Island ~
(Counter)



~ Island ~
(Counter)



~ Kitchen ~
(Counter)

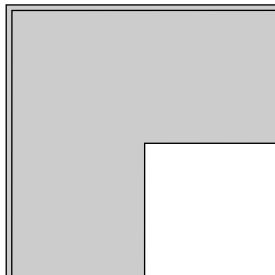

~ Kitchen Corner ~
(Counter)

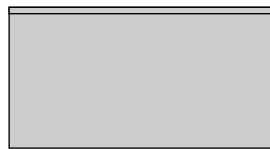

~ Lavatory ~
(Counter)

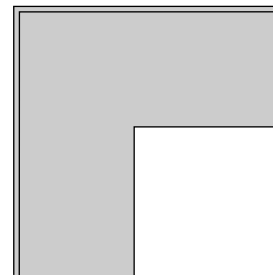

~ Lavatory Corner ~
(Counter)

Space Planning

| Chairs |

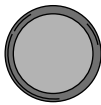

~ Stool ~
(16x16)

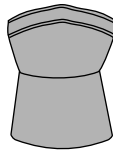

~ Dining Chair ~
(18x24)

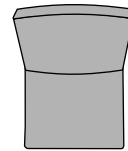

~ Parsons Chair ~
(20x24)

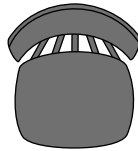

~ Dining Chair ~
(22x24)



~ Dining Chair ~
(22x24)

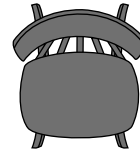

~ Rocker ~
(22x24)

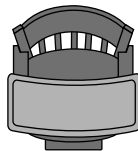

~ High Chair ~
(23x25)



~ Occasional Chair ~
(23x26)

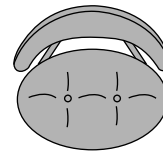

~ Occasional Tufted ~
(24x22)

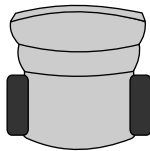

~ Office Chair ~
(25x25)

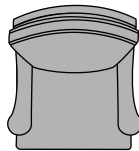

~ Arm w/Cushion ~
(27x27)

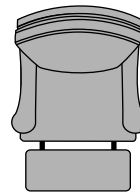

~ Recliner w/Cushion ~
(27x37)

Space Planning

| Chairs |

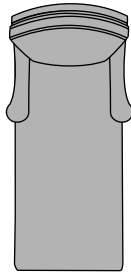

~ Chaise w/Cushion ~
(27x57)

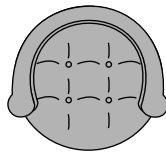

~ Round Tufted ~
(30x27)

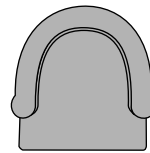

~ Barrel ~
(30x30)

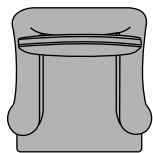

~ Lounge w/Cushion ~
(30x30)

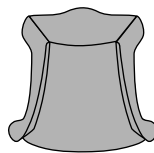

~ Wing ~
(33x32)

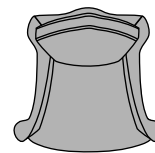

~ Wing w/Cushion ~
(33x32)

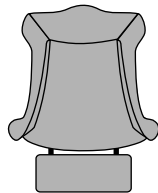

~ Wing Recliner ~
(33x41)

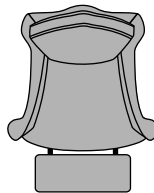

~ Wing Recliner ~
(33x41)

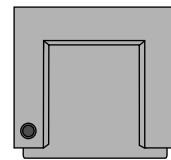

~ Media Chair ~
(34x32)

Space Planning

| Dressers |

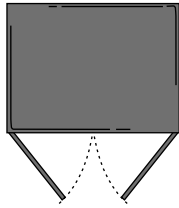

~ Armoire ~
(32x24)



~ Chest of Drawers ~
(30x18)

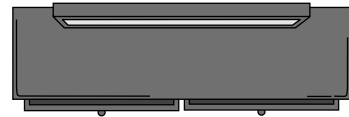

~ Dresser ~
(54x22)

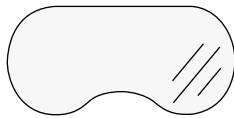

~ Dressing Table ~
(42x20)

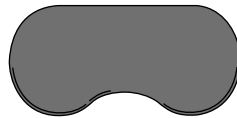

~ Dressing Table ~
(42x20)



~ Dressing Table ~
(42x22)



~ Dressing Table ~
(42x22)



~ Dressing Table ~
(42x22)

Space Planning

| Lavatory |

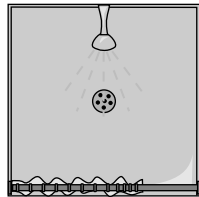

~ Shower w/Curtain ~
(32x32)

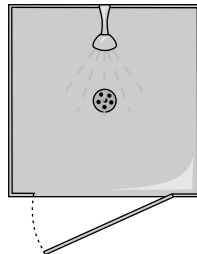

~ Shower w/Door ~
(32x32)

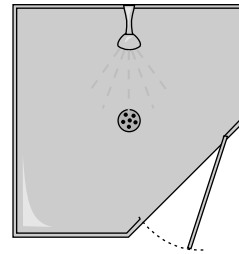

~ Shower Corner ~
(40x40)

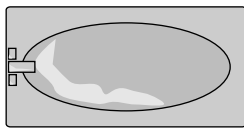

~ Tub Oval ~
(60x30)



~ Tub Rectangle ~
(60x30)

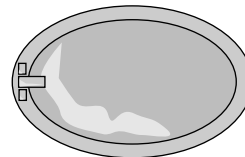

~ Tub Oval ~
(60x38)

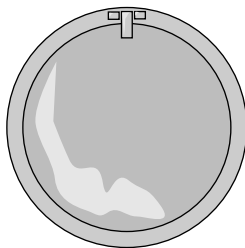

~ Tub Round ~
(60x60)

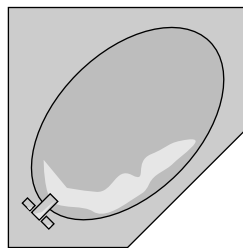

~ Tub Corner ~
(60x60)

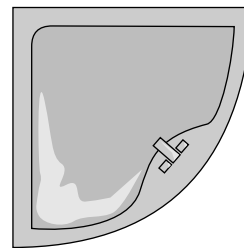

~ Tub Corner ~
(60x60)



~ Bidet ~

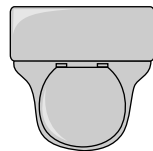

~ Low Profile ~

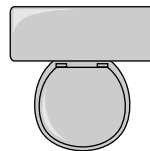

~ Tank ~



~ Wall Mounted ~

Space Planning

| Occasional Pieces |



~ Bookcase ~
(20x14)



~ Bookcase ~
(38x18)



~ Buffet ~
(54x24)

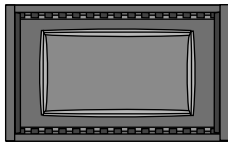

~ Changing Table ~
(36x22)



~ China Cabinet ~
(50x18)

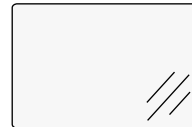

~ Console ~
(24x16)

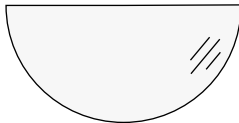

~ Console ~
(40x20)

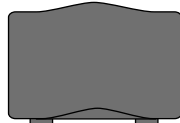

~ Curio ~
(24x17)



~ Desk ~
(40x18)

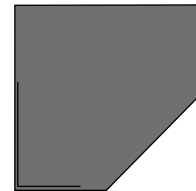

~ Desk Corner ~
(32x32)



~ Desk Secretary ~
(72x19)

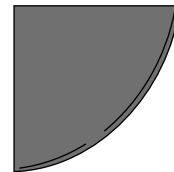

~ Media Corner ~
(24x24)

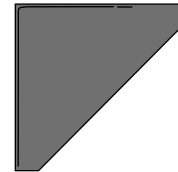

~ Media Corner ~
(28x28)

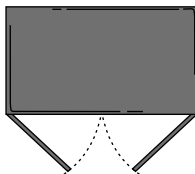

~ Media ~
(30x18)



~ Media ~
(30x18)

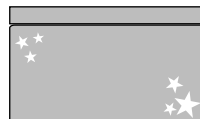

~ Toy Box ~
(29x17)



~ Trunk ~
(28x11)

Space Planning

| Sinks |

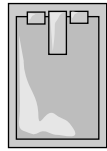

~ Island ~
(15x22)

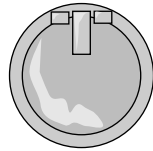

~ Island ~
(22x22)

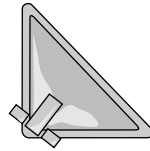

~ Island ~
(24x24)

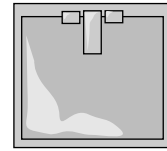

~ Kitchen ~
(24x22)

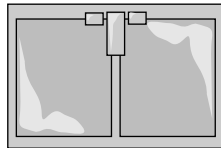

~ Kitchen ~
(33x22)

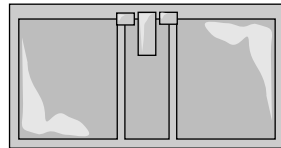

~ Kitchen ~
(42x22)

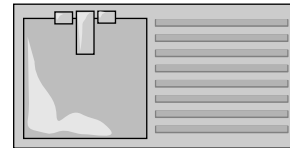

~ Kitchen ~
(43x22)

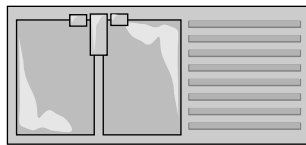

~ Kitchen ~
(48x22)

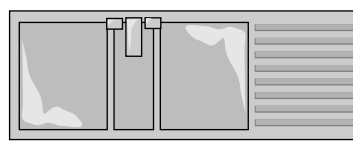

~ Kitchen ~
(60x22)

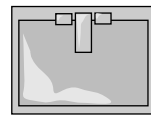

~ Laundry ~
(24x18)

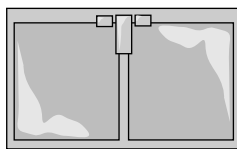

~ Laundry ~
(40x24)

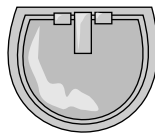

~ Pedestal ~
(24x20)

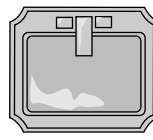

~ Pedestal ~
(25x21)

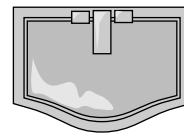

~ Pedestal ~
(27x19)

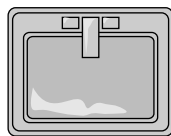

~ Pedestal ~
(27x21)

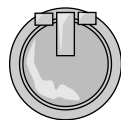

~ Vanity ~
(17x17)

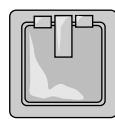

~ Vanity ~
(17x17)

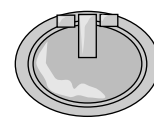

~ Vanity ~
(22x16)

Space Planning

| Sinks |

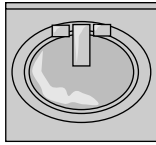

~ Vanity ~
(24x22)

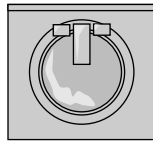

~ Vanity ~
(24x22)

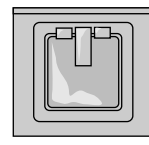

~ Vanity ~
(24x22)

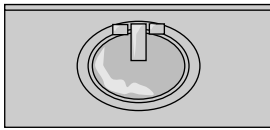

~ Vanity ~
(48x22)

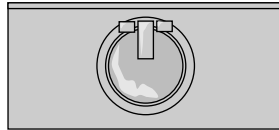

~ Vanity ~
(48x22)

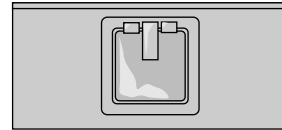

~ Vanity ~
(48x22)

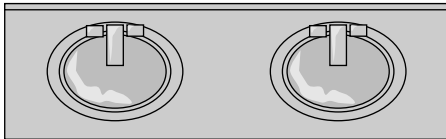

~ Vanity ~
(72x22)

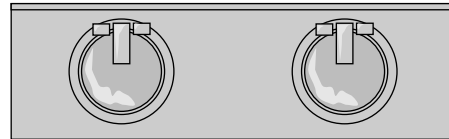

~ Vanity ~
(72x22)

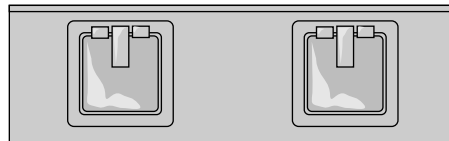

~ Vanity ~
(72x22)

Space Planning

| Sofas |

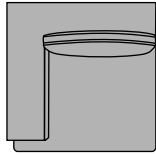

~ Sectional ~
(32x32)

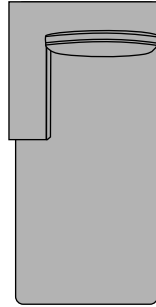

~ Sectional ~
(32x65)

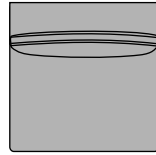

~ Sectional ~
(32x32)

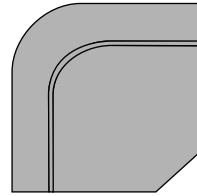

~ Sectional ~
(40x40)

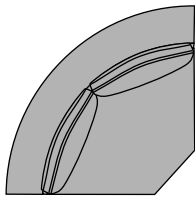

~ Sectional ~
(32x32)

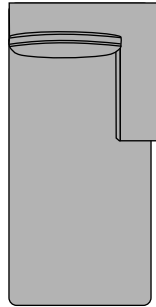

~ Sectional ~
(32x65)

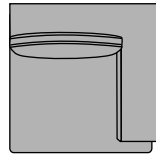

~ Sectional ~
(32x32)



~ Contemporary ~
(50x32)

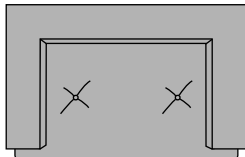

~ Contemporary ~
(50x32)

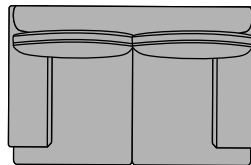

~ Cushions ~
(50x32)

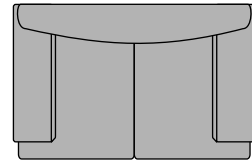

~ Tailored ~
(50x32)

Space Planning

| Sofas |

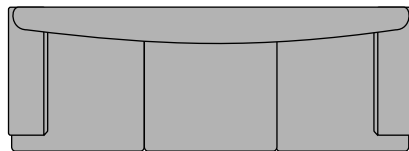
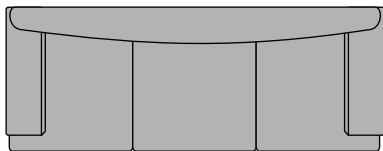
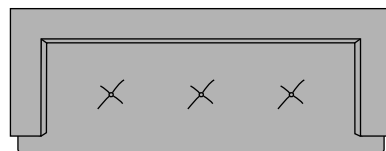
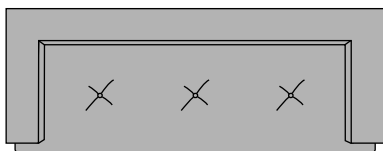
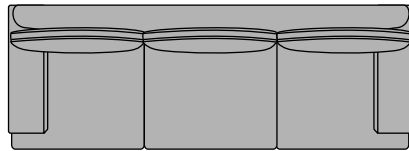
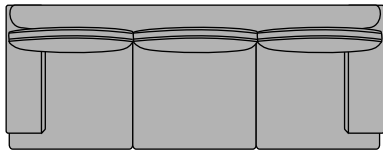
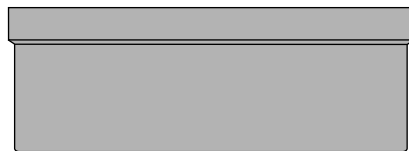
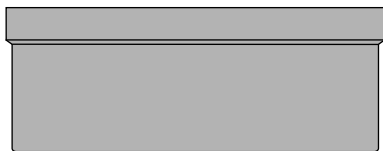
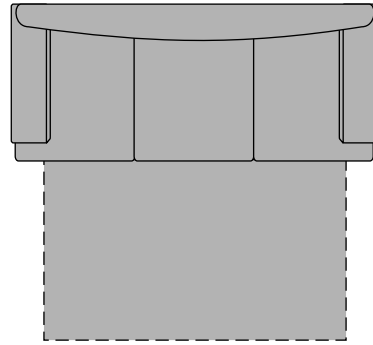
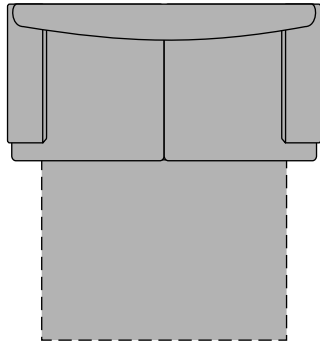

~ 84x32 ~

~ 96x32 ~

Space Planning

| Tables |

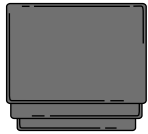

~ Nesting ~
(22x20)

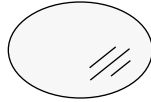

~ Oval ~
(18x12)

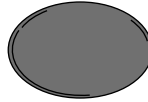

~ Oval ~
(18x12)

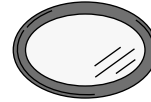

~ Oval ~
(18x12)

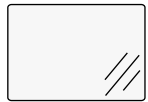

~ Rectangle ~
(20x14)



~ Rectangle ~
(20x14)



~ Rectangle ~
(20x14)



~ Round ~
(18x18)

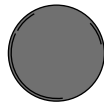

~ Round ~
(18x18)



~ Round ~
(18x18)



~ Shaped ~
(25x14)



~ Shaped ~
(25x16)



~ Square ~
(16x16)



~ Square ~
(16x16)



~ Square ~
(16x16)



~ Triangle ~
(20x29x29)



~ Triangle ~
(20x29x29)

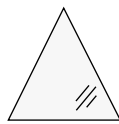

~ Triangle ~
(28x28x28)

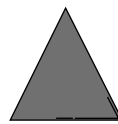

~ Triangle ~
(28x28x28)

